



Componenti osmosi domestica





RESIDENTIAL

RO elements for residential use (1.8 inch diameter)

CSM[®]

SPECIFICATIONS:

General Features

Model Name	Permeate Flow Rate GPD (L/day)	Salt Rejection %
RE1810-30	30 (114)	98.0%
RE1810-50	50 (189)	98.0%
RE1812-35	35 (132)	98.0%
RE1812-50	50 (189)	98.0%
RE1812-60	60 (227)	98.0%
RE1812-80	80 (303)	98.0%

1. The stated product performance is based on data taken after 30 minutes of operation at the following test conditions:

- 200 mg/L NaCl solution at 60 psig (0.41 MPa) applied pressure
- 15% recovery
- 77 °F (25 °C)
- pH 6.5–7.0

2. Dry type elements are vacuum leak tested using the San Diego Protocol.

3. Permeate flow rate for each element may vary but will be no more than 15%.

4. Dry elements are packaged in a polyethylene bag

▣ Wet elements are packaged in a polyethylene bag containing SB(4g/L) + HCl(0.5 l/g/L) solution.

Membrane type: Thin-Film Composite
Membrane material: Polyamide (PA)
Element configuration: Spiral-Wound, Tape Wrapping

Dimensions

Model Name	A	B	C	D	E
RE1810-30	0.67 (17mm)	0.55 (14mm)	10.08 (256mm)	0.98 (25mm)	1.77 (45mm)
RE1810-50					
RE1812-35	0.67 (17mm)	0.87 (22mm)	11.73 (298mm)	0.98 (25mm)	1.77 (45mm)
RE1812-50					
RE1812-60					
RE1812-80					

*All measurement are in inches



Membrane CSM Residenziali



These model names are tested and certified under NSF/ANSI standard 58, material requirement only (excluding RE1810-30)

RESIDENTIAL

RO elements for residential use (1.8 inch diameter)

CSM®

APPLICATION DATA:

Operating Limits

· Max. Operating Pressure	125 psi (0.86 MPa)
· Max. Feed Flow Rate	2 gpm (0.45 m ³ /hr)
· Max. Operating Temperature	113 °F (45 °C)
· Operating pH Range	2.0–11.0
· Max. Turbidity	1.0 NTU
· Max. SDI (15 min)	5.0
· Max. Chlorine Concentration	< 0.1 mg/L

The information provided in this document is solely for informative purposes. It is the user's responsibility to ensure the appropriate usage of this product. Woongjin Chemical assumes no obligation, liability or damages incurred for the misuse of the product or for the information provided in this document. This document does not express or implies any warranty as to the merchantability or fitness of the products.

GENERAL HANDLING PROCEDURES

- Elements contained in the boxes must be kept dry at room temperature (7–32°C; 40–95°F) and should not be stored in direct sunlight. If the polyethylene bag is damaged, a new preservative solution (sodium bisulfite) must be added and air-tight sealed to prevent drying and biological growth.
- Permeate from the first hour of operation should be discarded to flush out the preservative solution.
- Elements should be immersed in a preservative solution during storage, shipping and system shutdowns to prevent biological growth and freezing. The standard storage solution contains 1% by weight sodium bisulfite or sodium metabisulfite (food grade). For short term storage (i.e. one week or less) 1% by weight sodium metabisulfite solution is adequate for preventing biological growth.
- Keep elements moist at all times after initial wetting.
- Only use chemicals compatible with the membrane elements and components. Use of such chemicals may void the element limited warranty.
- Permeate pressure must always be equal or less than the feed/concentrate pressure. Damage caused by permeate back pressure voids the element limited warranty.

CODICE	MODELLO	
	RE1810-30	
	RE1812-35	
MCRE1812-50	RE1812-50	
MCRE1812-60	RE1812-60	
MCRE1812-80	RE1812-80	



RESIDENTIAL

High recovery & High rejection RO element for residential use

CSM[®]

SPECIFICATIONS:

General Features

Model Name	Permeate Flow Rate GPD (L/day)	Salt Rejection (%)	Pressure / Recovery
RE1812-HR+	80 (302.8)	99.0 (min. 97.5)	60psig / 30%
	105 (397.5)	96.0 (min. 95.0)	80psig / 60%

- The stated product performance is based on data taken after 30 minutes of operation at the following test conditions:
 - 200 mg/L NaCl solution , 77 °F (25 °C), pH 6.5–7.0
- All elements are vacuum leak tested using the CSM integrity test.
- Permeate flow rate for each element may vary +15/ -15%.
- Elements can be supplied as dry or wet-type. Wet-tested elements are soaked in a preservative solution (1.0% food grade SBS) and vacuum sealed in a poly bag. All elements are individually boxed.

Membrane type: Thin-Film Composite
Membrane material: Polyamide (PA)
Element configuration: Spiral-Wound, Tape Wrapping

Dimensions

Model Name	A	B	C	D	E
RE1812-HR+	0.67 inch (17mm)	0.87 inch (22 mm)	11.73 inch (298 mm)	0.87 inch (22 mm)	1.77 inch (45 mm)





RESIDENTIAL

High recovery & High rejection RO element for residential use

CSM®

APPLICATION DATA:

Operating Limits

· Max. Operating Pressure	150 psi (1.03 MPa)
· Max. Feed Flow Rate	2 gpm (0.45 m ³ /hr)
· Max. Operating Temperature	113 °F (45 °C)
· Operating pH Range	2.0–11.0
· Max. Turbidity	1.0 NTU
· Max. SDI (15 min)	3.0
· Max. Chlorine Concentration	< 0.1 mg/L

The information provided in this document is solely for informative purposes. It is the user's responsibility to ensure the appropriate usage of this product. Toray Chemical Korea Inc. assumes no obligation, liability or damages incurred for the misuse of the product or for the information provided in this document. This document does not express or implies any warranty as to the merchantability or fitness of the product.

GENERAL HANDLING PROCEDURES

- Elements contained in the boxes must be kept dry at room temperature (7–32°C; 40–95°F) and should not be stored in direct sunlight.
- When running the system for the first time, the permeate should be discarded continuously at least 1 hour.
- Keep elements moistly at all times after initial wetting.
- Elements should be immersed in a preservative solution during storage, shipping and system shutdowns to prevent biological growth and freezing. The standard storage solution contains 1% by weight sodium bisulfite or sodium metabisulfite (food grade). For short term storage (i.e. one week or less) 1% by weight sodium metabisulfite solution is adequate for preventing from biological growth.
- Keep elements moistly at all times after initial wetting.
- Only use chemicals compatible with the membrane elements and components. Use of such chemicals may void the element limited warranty. For additional information on use of approved chemicals please contact your nearest CSM representative.
- Permeate pressure must always be equal or less than the feed/concentrate pressure. Damage caused by permeate back pressure voids the element limited warranty.

CODICE	MODELLO
MCRE1812-HR+	RE1812-HR+



RESIDENTIAL

RO elements for residential use (2.0 and 2.8 inch diameters)

CSM®

SPECIFICATIONS:

General Features

Model Name	Permeate Flow Rate GPD (L/day)	Salt Rejection (%)
RE2012-100	100 (397)	98.0
RE2812-300	300 (1,136)	96.0

- The stated product performance is based on data taken after 30 minutes of operation at the following test conditions:
 - 200 mg/L NaCl solution at 60 psig (0.41 MPa) applied pressure
 - 15% recovery
 - 77 °F (25 °C)
 - pH 6.5–7.0
- Minimum salt rejection is 96.0%.
- Permeate flow rate for each element may vary but will be no more than 15%.
- Wet elements are packaged in a polyethylene bag containing 1.0% SBS (sodium bisulfite) solution.

Membrane type: Thin-Film Composite
Membrane material: Polyamide (PA)
Element configuration: Spiral-Wound, Tape Wrapping

Dimensions

Model Name	A	B	C	D	E
RE2012-100	0.67 (17)	0.5 (12)	11.7 (298)	0.9 (23)	1.9 (48)
RE2812-300	0.67 (17)	0.9 (22)	11.7 (298)	0.9 (22)	2.9 (74)

*All measurements are in inches (millimeters)





RESIDENTIAL

RO elements for residential use (2.0 and 2.8 inch diameters)

CSM®

APPLICATION DATA:

Operating Limits

· Max. Operating Pressure	125 psi (0.86 MPa)
· Max. Feed Flow Rate	2 gpm (0.45 m ³ /hr)
· Max. Operating Temperature	113 °F (45 °C)
· Operating pH Range	2.0–11.0
· Max. Turbidity	1.0 NTU
· Max. SDI (15 min)	5.0
· Max. Chlorine Concentration	< 0.1 mg/L

The information provided in this document is solely for informative purposes. It is the user's responsibility to ensure the appropriate usage of this product. Toray Chemical Korea Inc. assumes no obligation, liability or damages incurred for the misuse of the product or for the information provided in this document. This document does not express or imply any warranty as to the merchantability or fitness of the product.

GENERAL HANDLING PROCEDURES

- Elements contained in the boxes must be kept dry at room temperature (7–32°C; 40–95°F) and should not be stored in direct sunlight. If the polyethylene bag is damaged, a new preservative solution (sodium bisulfite) must be added and air-tight sealed to prevent drying and biological growth.
- When running the system for the first time, the permeate should be discarded continuously at least 1 hour.
- Keep elements moistly at all times after initial wetting.
- Elements should be immersed in a preservative solution during storage, shipping and system shutdowns to prevent biological growth and freezing. The standard storage solution contains 1% by weight sodium bisulfite or sodium metabisulfite (food grade). For short term storage (i.e. one week or less) 1% by weight sodium metabisulfite solution is adequate for preventing from biological growth.
- Only use chemicals compatible with the membrane elements and components. Use of such chemicals may void the element limited warranty.
- Permeate pressure must always be equal or less than the feed/concentrate pressure. Damage caused by permeate back pressure voids the element limited warranty.

CODICE	MODELLO	
MCRE2012-100	RE2012-100	
MCRE2812-300	RE2812-300	

Membrane CSM Residenziali



SPECIFICATIONS:

General Features

Model Name	Active Membrane Area ft ² (m ²)	Permeate Flow Rate GPD (L/day)	Salt Rejection (%)
RE2012-150	6.4 (0.59)	150 (567.8)	98.0

1. The stated product performance is based on data taken after 30 minutes of operation at the following test conditions:

- **200 mg/L NaCl solution at 60 psig (0.41 MPa) applied pressure**
- **15% recovery**
- **77 °F (25 °C)**
- **pH 6.5–7.0**

2. Minimum salt rejection is 96.0%.

3. Dry type elements are vacuum leak tested using the CSM integrity test.

4. Permeate flow rate for each element may vary but will be no more than 15%.

5. Dry elements are packaged in a polyethylene bag.

Membrane type:	Thin-Film Composite
Membrane material:	Polyamide (PA)
Element configuration:	Spiral-Wound, Tape Wrapping

Dimensions

Model Name	A	B	C	D	E
RE2012-150	0.67 (17)	0.5 (12)	11.7 (298)	0.9 (23)	1.9 (48)

*All measurements are in inches (millimeters).





RESIDENTIAL

High flux RO elements for residential use

CSM[®]

APPLICATION DATA:

Operating Limits

· Max. Operating Pressure	150 psi (1.03 MPa)
· Max. Feed Flow Rate	2 gpm (0.45 m ³ /hr)
· Max. Operating Temperature	113 °F (45 °C)
· Operating pH Range	2.0–11.0
· Max. Turbidity	1.0 NTU
· Max. SDI (15 min)	5.0
· Max. Chlorine Concentration	< 0.1 mg/L

The information provided in this document is solely for informative purposes. It is the user's responsibility to ensure the appropriate usage of this product. Toray Chemical Korea Inc. assumes no obligation, liability or damages incurred for the misuse of the product or for the information provided in this document. This document does not express or imply any warranty as to the merchantability or fitness of the product.

GENERAL HANDLING PROCEDURES

- Elements contained in the boxes must be kept dry at room temperature (7–32°C; 40–95°F) and should not be stored in direct sunlight.
- When running the system for the first time, the permeate should be discarded continuously at least 1 hour.
- Keep elements moistly at all times after initial wetting.
- Elements should be immersed in a preservative solution during storage, shipping and system shutdowns to prevent biological growth and freezing. The standard storage solution contains 1% by weight sodium bisulfite or sodium metabisulfite (food grade). For short term storage (i.e. one week or less) 1% by weight sodium metabisulfite solution is adequate for preventing from biological growth.
- Only use chemicals compatible with the membrane elements and components. Use of such chemicals may void the element limited warranty. For additional information on use of approved chemicals please contact your nearest CSM representative.
- Permeate pressure must always be equal or less than the feed/concentrate pressure. Damage caused by permeate back pressure voids the element limited warranty.

CODICE	MODELLO	
MCRE2012-150	RE2012-150	

Membrane CSM Residenziali



SPECIFICATIONS:

General Features

Model Name	Permeate Flow Rate GPD (L/day)	Salt Rejection (%)	Pressure / Recovery
RE2012-400	400 (1514)	96.0 (min. 95.0)	80psig / 30%

1. The stated product performance is based on data taken after 30 minutes of operation at the following test conditions:

- 200 mg/L NaCl solution , 77 °F (25 °C), pH 6.5–7.0

2. Wet type elements are vacuum leak tested using the CSM integrity test.

3. Permeate flow rate for each element may vary but will be no more than 15%.

4. Wet elements are packaged in a polyethylene bag containing 1.0% SBS (sodium bisulfite) solution.

Membrane type:	Thin-Film Composite
Membrane material:	Polyamide (PA)
Element configuration:	Spiral-Wound, Tape Wrapping

Dimensions

Model Name	A	B	C	D	E
RE2012-400	0.67 (17mm)	0.5 (12mm)	11.73 (298mm)	0.91 (23mm)	1.89 (48mm)

*All measurements are in inches (millimeters).

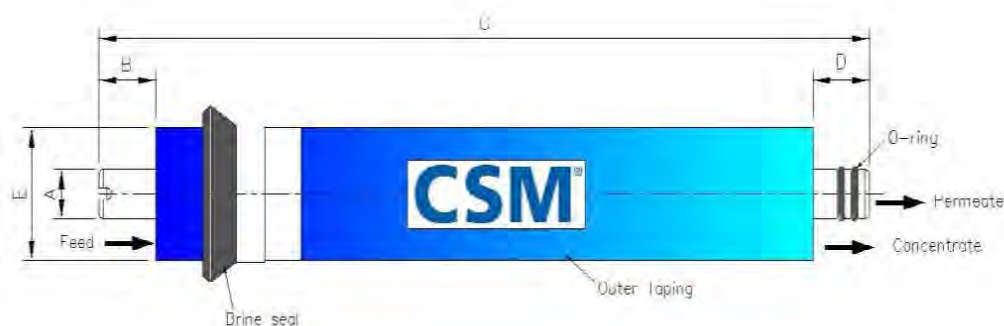



RESIDENTIAL

High recovery & High rejection RO element for residential use

CSM®

APPLICATION DATA:

Operating Limits

· Max. Operating Pressure	150 psi (1.03 MPa)
· Max. Feed Flow Rate	2 gpm (0.45 m ³ /hr)
· Max. Operating Temperature	113 °F (45 °C)
· Operating pH Range	2.0–11.0
· Max. Turbidity	1.0 NTU
· Max. SDI (15 min)	3.0
· Max. Chlorine Concentration	< 0.1 mg/L

The information provided in this document is solely for informative purposes. It is the user's responsibility to ensure the appropriate usage of this product. Toray Chemical Korea Inc. assumes no obligation, liability or damages incurred for the misuse of the product or for the information provided in this document. This document does not express or implies any warranty as to the merchantability or fitness of the product.

GENERAL HANDLING PROCEDURES

- Elements contained in the boxes must be kept dry at room temperature (7–32°C; 40–95°F) and should not be stored in direct sunlight.
- When running the system for the first time, the permeate should be discarded continuously at least 1 hour.
- Keep elements moistly at all times after initial wetting.
- Elements should be immersed in a preservative solution during storage, shipping and system shutdowns to prevent biological growth and freezing. The standard storage solution contains 1% by weight sodium bisulfite or sodium metabisulfite (food grade). For short term storage (i.e. one week or less) 1% by weight sodium metabisulfite solution is adequate for preventing from biological growth.
- Keep elements moistly at all times after initial wetting.
- Only use chemicals compatible with the membrane elements and components. Use of such chemicals may void the element limited warranty. For additional information on use of approved chemicals please contact your nearest CSM representative.
- Permeate pressure must always be equal or less than the feed/concentrate pressure. Damage caused by permeate back pressure voids the element limited warranty.

CODICE	MODELLO	
MCRE2012-400	RE2012-400	



RESIDENTIAL

Low pressure grade RO elements for residential use

CSM®

SPECIFICATIONS:

General Features

Model Name	Permeate Flow Rate GPD (L/day)	Salt Rejection %
RE2010-LP	30 (114)	93.0%
RE2012-LP	50 (189)	93.0%
RE2012-LPF	60 (227)	93.0%

1. The stated product performance is based on data taken after 30 minutes of operation at the following test conditions:

- 100 mg/L NaCl solution at 20 psig (0.14 MPa) applied pressure
- 15% recovery
- 77 °F (25 °C)
- pH 6.5–7.0

2. Dry type elements are vacuum leak tested using the San Diego Protocol.

3. Permeate flow rate for each element may vary but will be no more than 15%.

4. Dry elements are packaged in a polyethylene bag

 ⌘ Wet elements are packaged in a polyethylene bag containing SB(4g/L) + HCl(0.5 l g/L) solution.

Membrane type: Thin-Film Composite
Membrane material: Polyamide (PA)
Element configuration: Spiral-Wound, Tape Wrapping

Dimensions

Model Name	A	B	C	D	E
RE2010-LP	0.67	0.55	10.08	0.98	1.91
RE2012-LP	0.67	0.47	11.73	0.91	1.91
RE2012-LPF	0.67	0.47	11.73	0.91	1.91

*All measurement are in inches

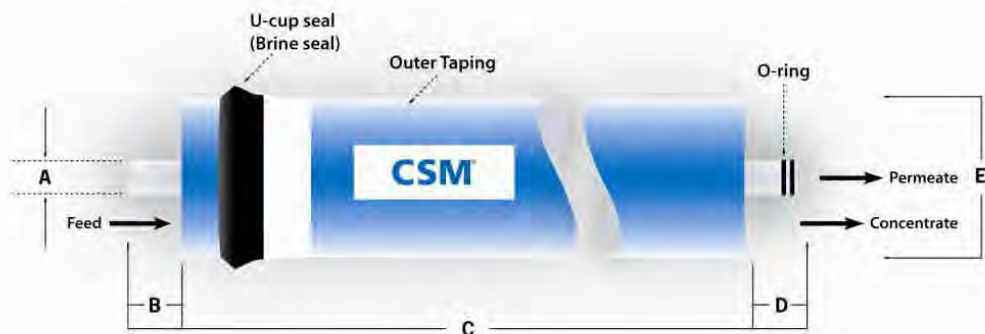



RESIDENTIAL

Low pressure grade RO elements for residential use

CSM®

APPLICATION DATA:

Operating Limits

· Max. Operating Pressure	125 psi (0.86 MPa)
· Max. Feed Flow Rate	2 gpm (0.45 m ³ /hr)
· Max. Operating Temperature	113 °F (45 °C)
· Operating pH Range	2.0–11.0
· Max. Turbidity	1.0 NTU
· Max. SDI (15 min)	5.0
· Max. Chlorine Concentration	< 0.1 mg/L

The information provided in this document is solely for informative purposes. It is the user's responsibility to ensure the appropriate usage of this product. Woongjin Chemical assumes no obligation, liability or damages incurred for the misuse of the product or for the information provided in this document. This document does not express or implies any warranty as to the merchantability or fitness of the product.

GENERAL HANDLING PROCEDURES

- Elements contained in the boxes must be kept dry at room temperature (7–32°C; 40–95°F) and should not be stored in direct sunlight. If the polyethylene bag is damaged, a new preservative solution (sodium bisulfite) must be added and air-tight sealed to prevent drying and biological growth.
- Permeate from the first hour of operation should be discarded to flush out the preservative solution.
- Elements should be immersed in a preservative solution during storage, shipping and system shutdowns to prevent biological growth and freezing. The standard storage solution contains 1% by weight sodium bisulfite or sodium metabisulfite (food grade). For short term storage (i.e. one week or less) 1% by weight sodium metabisulfite solution is adequate for preventing biological growth.
- Keep elements moist at all times after initial wetting.
- Only use chemicals compatible with the membrane elements and components. Use of such chemicals may void the element limited warranty.
- Permeate pressure must always be equal or less than the feed/concentrate pressure. Damage caused by permeate back pressure voids the element limited warranty.

CODICE	MODELLO	
	RE2010-LP	
MCRE2012-LP	RE2012-LP	
MCRE2012-LPF	RE2012-LPF	



RESIDENTIAL

RO elements for residential use

CSM®

SPECIFICATIONS:

General Features

Model Name	Permeate Flow Rate GPD (L/day)	Salt Rejection (%)
RE3012-500	500 (1,893)	97.0

1. The stated product performance is based on data taken after 30 minutes of operation at the following test conditions:

- 200 mg/L NaCl solution at 80 psig (0.55 MPa) applied pressure
- 40% recovery
- 77 °F (25 °C)
- pH 6.5–7.0

2. Minimum salt rejection is 95.0%.

3. Dry type elements are vacuum leak tested using the CSM integrity test.

4. Permeate flows for warranty evaluation may vary +25/-15%.

5. Dry elements are packaged in a polyethylene bag

α Wet elements are packaged in a polyethylene bag containing storage solution.

Membrane type:	Thin-Film Composite
Membrane material:	Polyamide (PA)
Element configuration:	Spiral-Wound, Tape Wrapping

Dimensions

Model Name	A	B	C	D	E
RE3012-500	0.67 (17)	0.39 (10)	11.7 (298)	0.79 (20)	2.95 (75)

*All measurement are in inches(millimeters)





RESIDENTIAL

RO elements for residential use

CSM®

APPLICATION DATA:

Operating Limits

· Max. Operating Pressure	150 psi (1.03 MPa)
· Max. Feed Flow Rate	2 gpm (0.45 m ³ /hr)
· Max. Operating Temperature	113 °F (45 °C)
· Operating pH Range	2.0–11.0
· Max. Turbidity	1.0 NTU
· Max. SDI (15 min)	5.0
· Max. Chlorine Concentration	< 0.1 mg/L

The information provided in this document is solely for informative purposes. It is the user's responsibility to ensure the appropriate usage of this product. Toray Chemical Korea Inc. assumes no obligation, liability or damages incurred for the misuse of the product or for the information provided in this document. This document does not express or implies any warranty as to the merchantability or fitness of the products.

GENERAL HANDLING PROCEDURES

- Elements contained in the boxes must be kept dry at room temperature (7–32°C; 40–95°F) and should not be stored in direct sunlight. If the polyethylene bag of wet element is damaged, a new preservative solution must be added and air-tight sealed to prevent drying and biological growth.
- When running the system for the first time, the permeate should be discarded continuously at least 1 hour.
- Keep elements moistly at all times after initial wetting.
- Elements should be immersed in a preservative solution during storage, shipping and system shutdowns to prevent biological growth and freezing. The standard storage solution contains 1% by weight sodium bisulfite or sodium metabisulfite (food grade). For short term storage (i.e. one week or less) 1% by weight sodium metabisulfite solution is adequate for preventing from biological growth.
- Only use chemicals compatible with the membrane elements and components. Use of such chemicals may void the element limited warranty.
- Permeate pressure must always be equal or less than the feed/concentrate pressure. Damage caused by permeate back pressure voids the element limited warranty.

CODICE	MODELLO	
MCRE3012-500	RE3012-500	



RESIDENTIAL

Tankless RO elements for residential use

CSM®

SPECIFICATIONS:

General Features

Model Name	Permeate Flow Rate GPD (L/day)	Salt Rejection (%)
RE35 I2-TK	600 (2,271)	95.0

1. The stated product performance is based on data taken after 30 minutes of operation at the following test conditions:

- 200 mg/L NaCl solution at 60 psig (0.41 MPa) applied pressure
- 30% recovery
- 77 °F (25 °C)
- pH 6.5–7.0

2. Minimum salt rejection is 93.0%.

3. Dry type elements are vacuum leak tested using the CSM integrity test.

4. Permeate flow rate for each element may vary but will be no more than 15%.

5. Dry elements are packaged in a polyethylene bag.

Membrane type:	Thin-Film Composite
Membrane material:	Polyamide (PA)
Element configuration:	Spiral-Wound, Tape Wrapping

Dimensions

Model Name	A	B	C	D	E
RE35 I2-TK	0.67 (17)	0.31 (8)	11.73 (298)	0.63 (16)	3.35 (85)

*All measurements are in inches (millimeters).





RESIDENTIAL

Tankless RO elements for residential use

CSM[®]

APPLICATION DATA:

Operating Limits

· Max. Operating Pressure	150 psi (1.03 MPa)
· Max. Feed Flow Rate	5 gpm (1.14 m ³ /hr)
· Max. Operating Temperature	113 °F (45 °C)
· Operating pH Range	2.0–11.0
· Max. Turbidity	1.0 NTU
· Max. SDI (15 min)	5.0
· Max. Chlorine Concentration	< 0.1 mg/L

The information provided in this document is solely for informative purposes. It is the user's responsibility to ensure the appropriate usage of this product. Toray Chemical Korea Inc. assumes no obligation, liability or damages incurred for the misuse of the product or for the information provided in this document. This document does not express or imply any warranty as to the merchantability or fitness of the product.

GENERAL HANDLING PROCEDURES

- Elements contained in the boxes must be kept dry at room temperature (7–32°C; 40–95°F) and should not be stored in direct sunlight.
- When running the system for the first time, the permeate should be discarded continuously at least 1 hour.
- Keep elements moistly at all times after initial wetting.
- Elements should be immersed in a preservative solution during storage, shipping and system shutdowns to prevent biological growth and freezing. The standard storage solution contains 1% by weight sodium bisulfite or sodium metabisulfite (food grade). For short term storage (i.e. one week or less) 1% by weight sodium metabisulfite solution is adequate for preventing from biological growth.
- Only use chemicals compatible with the membrane elements and components. Use of such chemicals may void the element limited warranty. For additional information on use of approved chemicals please contact your nearest CSM representative.
- Permeate pressure must always be equal or less than the feed/concentrate pressure. Damage caused by permeate back pressure voids the element limited warranty.

CODICE	MODELLO	
MCRE3512-TK	RE3512-TK	



RESIDENTIAL

NF elements for residential use

CSM[®]

SPECIFICATIONS:

General Features

Model Name	Permeate Flow Rate GPD (L/day)	Salt Rejection %
NE1812	80 (379)	40.0–60.0%
NE2010	90 (341)	40.0–60.0%

- The stated product performance is based on data taken after 30 minutes of operation at the following test conditions:
 - 250 mg/L NaCl solution at 60 psig (4.14 MPa) applied pressure
 - 15% recovery
 - 77 °F (25 °C)
 - pH 6.5–7.0
- Dry type elements are vacuum leak tested using the San Diego Protocol.
- Permeate flow rate for each element may vary but will be no more than 15%.
- All elements are packaged in a polyethylene bag containing 1.0% SBS (sodium bisulfite) solution.

Membrane type: Thin-Film Composite
Membrane material: Polyamide (PA)
Element configuration: Spiral-Wound, Tape Wrapping

Dimensions

Model Name	A	B	C	D	E
NE1812	0.67	0.87	11.73	0.87	1.77
NE2010	0.67	0.63	10.08	0.87	1.91

*All measurement are in inches

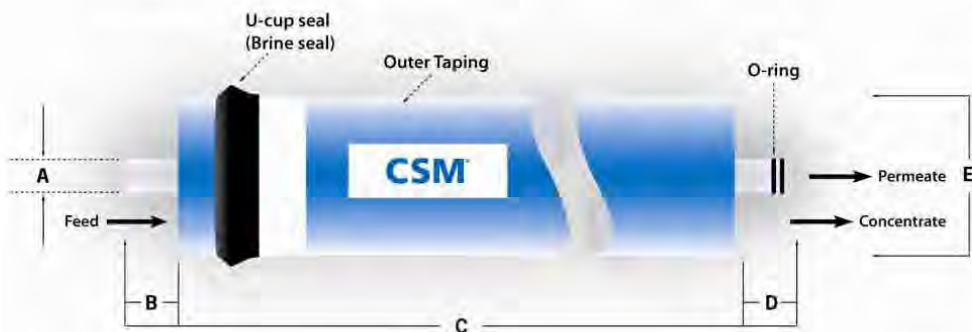



RESIDENTIAL

NF elements for residential use

CSM®

APPLICATION DATA:

Operating Limits

· Max. Operating Pressure	125 psi (0.86 MPa)
· Max. Feed Flow Rate	2 gpm (0.45 m ³ /hr)
· Max. Operating Temperature	113 °F (45 °C)
· Operating pH Range	2.0–11.0
· Max. Turbidity	1.0 NTU
· Max. SDI (15 min)	5.0
· Max. Chlorine Concentration	< 0.1 mg/L

The information provided in this document is solely for informative purposes. It is the user's responsibility to ensure the appropriate usage of this product. Woongjin Chemical assumes no obligation, liability or damages incurred for the misuse of the product or for the information provided in this document. This document does not express or implies any warranty as to the merchantability or fitness of the product.

GENERAL HANDLING PROCEDURES

- Elements contained in the boxes must be kept dry at room temperature (7–32°C; 40–95°F) and should not be stored in direct sunlight. If the polyethylene bag is damaged, a new preservative solution (sodium bisulfite) must be added and air-tight sealed to prevent drying and biological growth.
- Permeate from the first hour of operation should be discarded to flush out the preservative solution.
- Elements should be immersed in a preservative solution during storage, shipping and system shutdowns to prevent biological growth and freezing. The standard storage solution contains 1% by weight sodium bisulfite or sodium metabisulfite (food grade). For short term storage (i.e. one week or less) 1% by weight sodium metabisulfite solution is adequate for preventing biological growth.
- Keep elements moist at all times after initial wetting.
- Only use chemicals compatible with the membrane elements and components. Use of such chemicals may void the element limited warranty.
- Permeate pressure must always be equal or less than the feed/concentrate pressure. Damage caused by permeate back pressure voids the element limited warranty.

CODICE	MODELLO	
MCNE1812	NE1812	
	NE2010	



RESIDENTIAL

UF elements for residential use

CSM[®]

SPECIFICATIONS:

General Features

Model Name	Permeate Flow Rate GPD (L/day)	Molecular Weight Cut Off
UE1810	200 (757)	100K
UE1812	250 (946)	100K
UE2010	450 (1,703)	100K

1. The stated product performance is based on data taken after 30 minutes of operation at the following test conditions:

- Pure water (2 MΩ) at 20 psig applied pressure
- 100% recovery
- 77 °F (25 °C)

2. Dry type elements are vacuum leak tested using the San Diego Protocol.
3. Permeate flow rate for each element may vary but will be no more than 15%.
4. Dry elements are packaged in a polyethylene bag
 - α Wet elements are packaged in a polyethylene bag containing SB(4g/L) + HCl(0.51g/L) solution.

Membrane type: Thin-Film Composite
Membrane material: Polysulfone (PSF)
Element configuration: Spiral-Wound, Tape Wrapping

Dimensions

Model Name	A	B	C	D	E
UE1810	0.67	0.55	10.08	0.98	1.77
UE1812	0.67	0.55	11.02	0.79	1.77
UE2010	0.67	0.55	10.08	0.98	1.91

*All measurement are in inches



These model names are tested and certified under NSF/ANSI standard 58, material requirement only (excluding UE1812)



RESIDENTIAL

UF elements for residential use

CSM®

APPLICATION DATA:

Operating Limits

· Max. Operating Pressure	125 psi (0.86 MPa)
· Max. Feed Flow Rate	2 gpm (0.45 m ³ /hr)
· Max. Operating Temperature	113 °F (45 °C)
· Operating pH Range	2.0–11.0
· Max. Turbidity	1.0 NTU
· Max. SDI (15 min)	5.0

The information provided in this document is solely for informative purposes. It is the user's responsibility to ensure the appropriate usage of this product. Woongjin Chemical assumes no obligation, liability or damages incurred for the misuse of the product or for the information provided in this document. This document does not express or imply any warranty as to the merchantability or fitness of the product.

GENERAL HANDLING PROCEDURES

- Elements contained in the boxes must be kept dry at room temperature (7–32°C; 40–95°F) and should not be stored in direct sunlight. If the polyethylene bag is damaged, a new preservative solution (sodium bisulfite) must be added and air-tight sealed to prevent drying and biological growth.
- Permeate from the first hour of operation should be discarded to flush out the preservative solution.
- Elements should be immersed in a preservative solution during storage, shipping and system shutdowns to prevent biological growth and freezing. The standard storage solution contains 1% by weight sodium bisulfite or sodium metabisulfite (food grade). For short term storage (i.e. one week or less) 1% by weight sodium metabisulfite solution is adequate for preventing biological growth.
- Keep elements moist at all times after initial wetting.
- Only use chemicals compatible with the membrane elements and components. Use of such chemicals may void the element limited warranty.
- Permeate pressure must always be equal or less than the feed/concentrate pressure. Damage caused by permeate back pressure voids the element limited warranty.

CODICE	MODELLO	
	UE1810	
MCUE1812 (*)	UE1812	
	UE2010	

(*) disponibile fino ad esaurimento scorte.

Contenitori per Membrane Residenziali



1,8" - 2"

- In polipropilene, di colore bianco;
- Con attacchi 1/8" NPT F;
- Pressione massima 125 psi (8,6 bar);
- Con doppio o-ring di tenuta;
- Sede tubo permeato diametro = 0,67";
- Dimensione nominale 1812 - 2012.



CODICE	
DE010	

Membrane abbinabili a catalogo:

- Membrane CSM residenziali 1,8" e 2" a catalogo, vedi schede 10-01-01-IT, 10-01-02-IT, 10-01-03-IT, 10-01-04-IT, 10-01-07-IT e 10-01-08-IT.

Clips per contenitore membrane residenziali 1,8" - 2"

- In PP;
- Di colore bianco.

CODICE	
DE034	



2,8" - 3"

- In polipropilene, di colore bianco;
- Con attacchi:
 - Ingresso, permeato e scarto 3/8" NPT F (usare i raccordi dritti AV153 o a gomito AV159);
- Pressione massima 125 psi (8,6 bar);
- Sede tubo permeato diametro = 0,67";
- Dimensione nominale 2812 - 3012.



CODICE	
DE007	

Membrane abbinabili a catalogo:

- Membrane CSM residenziali 2,8" a catalogo, vedi scheda 10-01-02-IT e 10-01-05-IT.

Clips per contenitore membrane residenziali 3"

- In PP;
- Di colore bianco.

CODICE	
DE006	



Filtri In-Line



- Ideali per la filtrazione dell'acqua ad uso domestico;
- Con attacchi ¼" NPT F;
- Pressione massima pari a 100 psi (7 bar);
- Temperatura massima pari a 35°C;
- Conformi al D.M. n.174 del 06/04/2004 per materiali idonei al contatto con acque destinate al consumo umano.

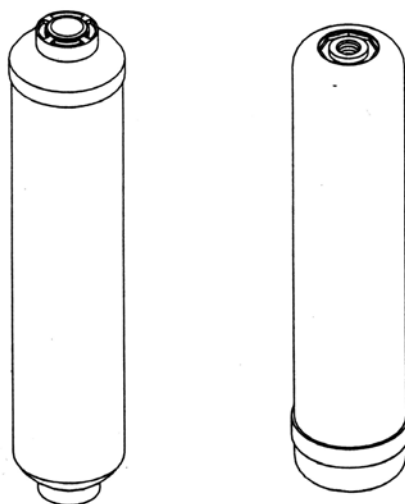

CODICE	DIAMETRO (pollici)	LUNGHEZZA (pollici)	MEZZO FILTRANTE	PORTATA (gpm)	
DE028	2"	10"	Carbone attivo di origine vegetale	0,75	
DE029	2"	10"	Sedimenti	0,75	
DE030	2 ½"	11"	Carbone attivo di origine vegetale	1,00	
DE031	2 ½"	11"	Sedimenti	1,00	

Gruppo compatto osmosi e relativi accessori

CODICE	DESCRIZIONE	
DE100	Gruppo compatto vuoto	
DE101	Membrana speciale 50 GPD	
DE102A	Cartuccia prefiltro sediment / carbon block	
DE103	Cartuccia GAC postfiltro	

Pompa Permeato per Osmosi Residenziali



- Pompa meccanica, senza alimentazione elettrica;
 - Utilizza l'energia dell'acqua di scarico del sistema osmosi per aumentare la pressione operativa netta sulla membrana, eliminando gli effetti negativi della contropressione che si crea sulla membrana man mano che il serbatoio di stoccaggio si riempie;
 - Adatta per sistemi osmosi domestici con serbatoio di stoccaggio pressurizzato e membrana da 35 a 100 GPD;
 - In grado di migliorare fino a 5 volte il tasso di recupero del sistema, riducendo il consumo d'acqua e riducendo il tempo di riempimento del serbatoio di stoccaggio;
 - Elimina la necessità della valvola shut-off.
- In polipropilene / EPDM;
 - Pressione massima di esercizio pari a 6,8 bar;
 - Con attacchi per tubo 1/4";
 - Portata massima allo scarico pari a 0,8 l/min.

CODICE	
DE120	

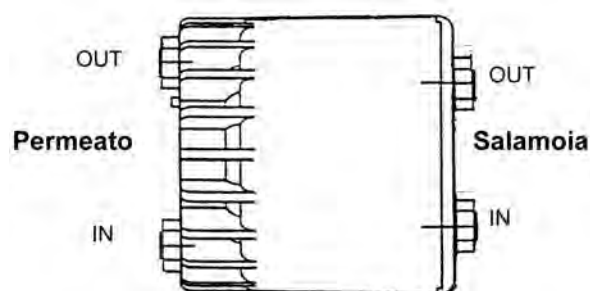

Schema tipico di installazione

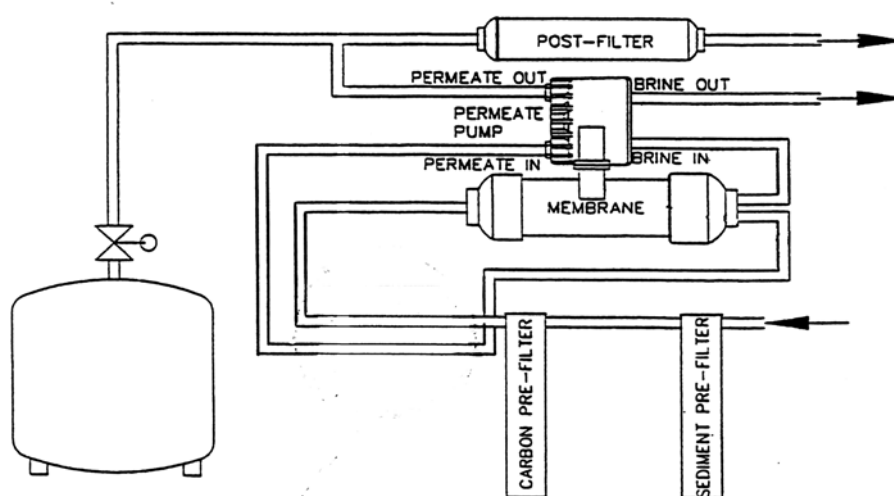

ATTENZIONE

Montare la pompa in orizzontale con le uscite in alto per evitare di intrappolare aria.
Il flow restrictor sul concentrato deve essere posizionato prima dell'ingresso alla pompa.

ACCESSORIO		
CODICE	DESCRIZIONE	
DE121	CLIP DI FISSAGGIO SU STAFFA	

Pompa Booster per Osmosi Residenziali



- Ideali per sistemi residenziali osmosi inversa.
- A membrana;
- Completa di trasformatore;
- Alimentazione trasformatore 220 V – 50 Hz;
- Con attacchi IN/OUT 3/8" F.

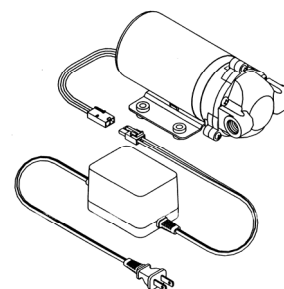

CODICE	MODELLO	ALIMENTAZIONE	PORTATA (l/min)		
			60 psi	100 psi	
DE130(*)	E36	24 VAC	0,8	0,6	

(*) disponibile fino ad esaurimento scorte

Accessori:

Pressostato di massima/ minima

- Pressione 30 ÷ 50 psi;
- Con attacchi per tubo 1/4".

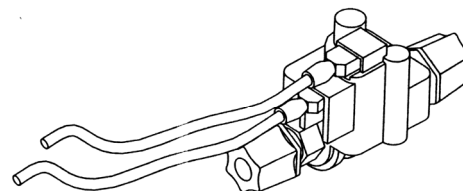

CODICE	
DE140	

- Per utilizzo come pressostato di massima contatti C e NC;
- Per utilizzo come pressostato di minima contatti C e NO.

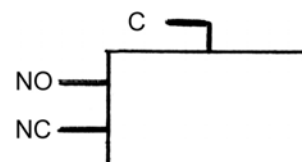

Schema tipico di installazione

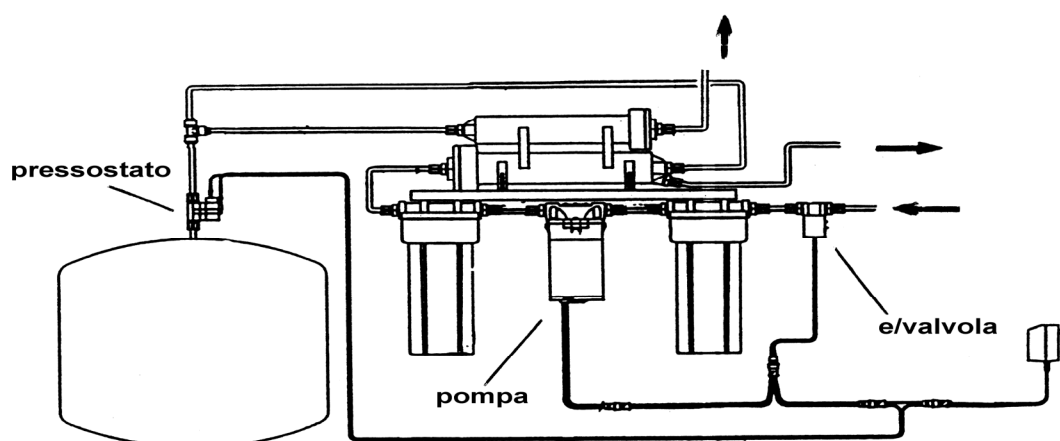

Pompe Booster MWG per Osmosi Residenziali



- Ideali per sistemi residenziali osmosi inversa;
- A membrana;
- Trasformatore da ordinare separatamente;
- Con attacchi IN/OUT 3/8" F;
- Conformi alle prescrizioni delle normative CE di sicurezza;
- Conformi al D.M. n.174 del 06/04/2004 per materiali idonei al contatto con acque destinate al consumo umano.



CODICE	MODELLO	ALIMENTAZIONE	CODICE TRASFORMATORE	PRESSIONE DI INGRESSO (psi)	PRESSIONE DI LAVORO (psi)	PORTATA A 70 psi (l/min)	CORRENTE NOMINALE (A)	CORRENTE A 70 psi (A)	
DH501	M100G	24 VDC	DH531	30	60 ÷ 80	≥ 1,1	1,8	≤ 1,2	
DH503	L200G	24 VDC	DH533	30	60 ÷ 80	≥ 1,6	2,2	≤ 1,6	
DH505	L400G	24 VDC	DH535	30	70 ÷ 90	≥ 2,6	3,6	≤ 2,5	

TRASFORMATORI

CODICE	MODELLO	
DH531	24VDC 2,0A	
DH533	24VDC 2,5A	
DH535	24VDC 4,0A	

DH501

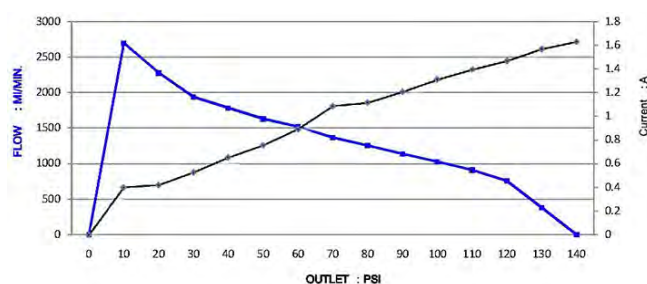

DH505

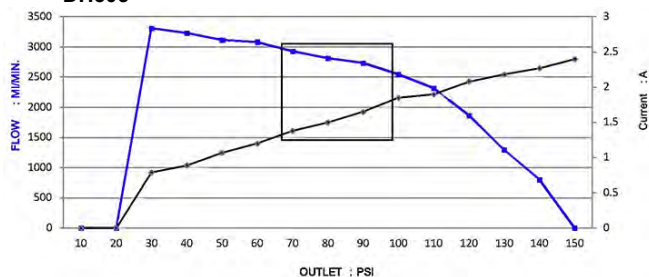

DH503

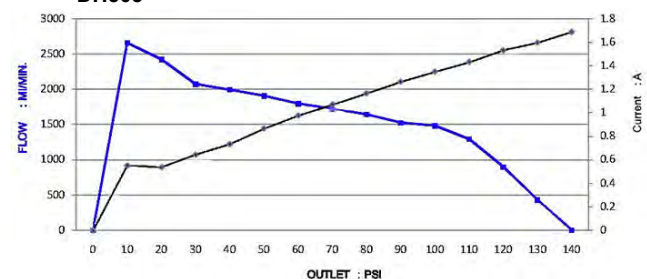

Elettrovalvole per Sistemi Osmosi



- A 2 vie NC ad azione diretta;
- Con corpo in nylon caricato vetro;
- Con attacco 1/4" NPT;
- Alimentazione 24 VAC;
- Con diametro orifizio pari a 2,5 mm.



CODICE	
DE142	

- A 2 vie NC ad azione diretta;
- Con corpo in ottone.



Codice DE144



Codice DE147

CODICE	ATTACCHI (pollici)	ALIMENTAZIONE	DIAMETRO ORIFIZIO (mm)	
DE144	1/4"	24 VDC	3,0	
DE147	3/8"	220 VAC	4,5	

Presa Acqua con Rubinetto Auto perforante



- Ideali per sistemi filtrazione e osmosi inversa domestici;
- Adatta per tubazioni in rame;
- Con attacco per tubo 1/4";
- In ottone con adattatore in alluminio.



CODICE	
DE041	

Presac acqua con rubinetto

- Ideali per sistemi filtrazione e osmosi inversa domestici;
- Per tubazione attacchi 1/2" M/F o 3/8" M/F;
- Con connessione per tubo flessibile 1/4" o 3/8" o 5/16";
- In ottone.



CODICE	TUBAZIONE (pollici)	TUBAZIONE FLESSIBILE (pollici)	
DE039	1/2" M/F	1/4"	
DE050	1/2" M/F	3/8"	
DE050A	1/2" M/F	5/16"	
DE039A	3/8" M/F	1/4"	



- Ideali per sistemi filtrazione e osmosi inversa domestici.

Raccordo di scarico concentrato

- In ABS di colore nero.

CODICE	ATTACCO (pollici)	
DE040	1/4" tubo	
DE049	1/4" F NPT	



Preso d'acqua a deviatore con collare girevole

- Con attacco per tubo 1/4";
- In ottone cromato.

CODICE	
DE042	



Adattatore 15/16" - 27 X 55/64" - 27

- Con spessore pari a 8 mm;
- In ottone cromato.

CODICE	
DE043	



Raccordi Tipo Jaco



- Adatti per la realizzazione di sistemi domestici di filtrazione o osmosi inversa;
- In polipropilene;
- Di colore bianco.

RACCORDI DIRITTI			
CODICE	ATTACCO FILETTATO (pollici)	PER TUBAZIONE (pollici)	
DE063	1/8"	1/4"	
DE064	1/4"	1/4"	
DE068	1/4" F	1/4"	
DE069	3/8"	1/4"	



RACCORDI A GOMITO			
CODICE	ATTACCO FILETTATO (pollici)	PER TUBAZIONE (pollici)	
DE060	1/8"	1/4"	
DE062	1/8" F	1/4"	
DE061	1/4"	1/4"	
DE070	3/8"	1/4"	

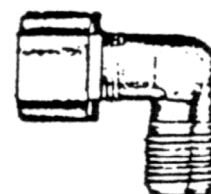

RACCORDI A T				
CODICE	POSIZIONE FILETTO 1/4"	ATTACCO FILETTATO (pollici)	PER TUBAZIONE (pollici)	
DE065	LATERALE	1/4"	1/4"	
DE066	CENTRALE	1/4"	1/4"	
DE067	-	-	1/4"	

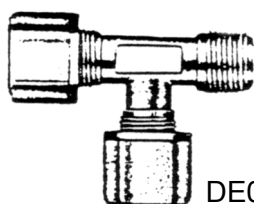

DE065

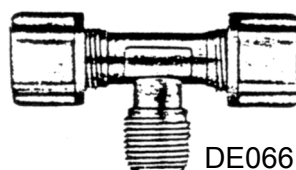

DE066

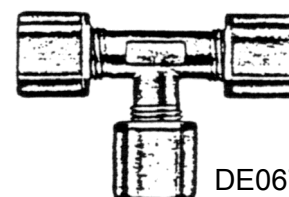

DE067

PASSA PARETE		
CODICE	PER TUBAZIONE (pollici)	
DE085 (*)	1/4"	



(*) disponibile fino ad esaurimento scorte.

Regolatori Flusso – Check Valves



Regolatori di flusso in-line

- Attacco rapido per tubo 1/4".

CODICE	PORTATA A 60 psi (gpd)	PORTATA A 60 psi (ml/min)	
DE105	60	150	
DE106	115	300	
DE107	150	400	
DE108	208	550	
DE109	227	600	
DE110	300	800	

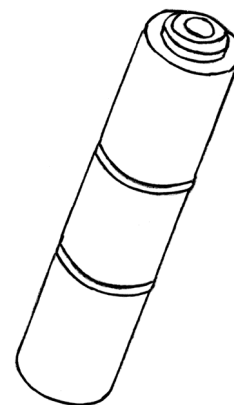

Raccordo a gomito

- Raccordo a gomito 1/8" x 1/4" tubo con inserto check-valve in AISI.

CODICE	
DE079	

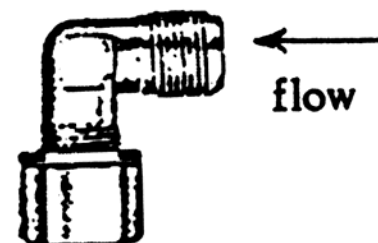

Check Valve

- In AISI 1/8" x 1/8".

CODICE	
DE048	

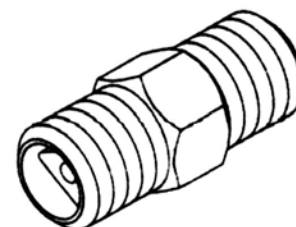



Serbatoio di stoccaggio in PP

- A membrana;
- Pressurizzato;
- Ideale per acqua osmotizzata;
- Di colore bianco;
- Con attacco ¼" NPT;
- Pressione minima di esercizio = 1 bar.



CODICE	CAPACITA' (litri)	MATERIALE	DIAMETRO (mm)	ALTEZZA (mm)	P MAX (bar)	
DE032	12	PP / acciaio	240	370	7,0	
DE051	15	PP	260	400	3,5	

Serbatoio di stoccaggio in acciaio

- A membrana;
- Pressurizzato;
- Ideale per acqua osmotizzata;
- In acciaio verniciato, di colore bianco;
- Con attacco 1" BSPP femmina;
- Con prolunga filettata M 1" x ¼", completa di valvola a sfera a gomito con attacco ¾" tubo;
- Pressione minima di esercizio = 1 bar;
- Pressione massima di esercizio = 7 bar.



CODICE	CAPACITA' (litri)	DIAMETRO (mm)	ALTEZZA (mm)	
DE096	41	390	575	
DE097	75	390	770	



Valvola a Sfera a Gomito

- In materiale plastico;
- Di colore bianco;
- Con attacchi 1/4" F NPT x 1/4" tubo.

CODICE	
DE052	



Valvola Shut-Off a Due Vie

- In materiale ABS;
- Di colore bianco;
- Con attacchi per tubo 1/4";
- Pressione massima pari a 125 psi (8,5 bar).

CODICE	
DE038	



Contalitri Meccanico

- A scala regolabile;
- Con blocco acqua ad esaurimento precarica;
- Con capacità 7000 litri;
- Attacchi 1/4" NPT;
- Pressione operativa 1 ÷ 8,5 bar;
- In materiale ABS, di colore nero.

CODICE	
DE080	





Clips di Fissaggio

- In polipropilene;
- Di colore bianco.

CODICE	DIAMETRO (pollici)	DIAMETRO (mm)	
DE033	2"	50	
DE034	2 1/2"	60	
DE006	3"	90	



Clips di Fissaggio Doppie

- In polipropilene;
- Di colore bianco.

CODICE	DIAMETRO (pollici)	DIAMETRO (mm)	
DE035	2" x 2 1/2"	50 x 60	
DE036	2 1/2" x 2 1/2"	60 x 60	



Tubo flessibile 1/4"

- Rotoli da 50 m (100 m solamente per DE081).

CODICE	DIAMETRO (pollici)	DIAMETRO (mm)	
DE082	PVC	Bianco	
DE083	PE	Azzurro	
DE084	PE	Nero	
DE086	PE	Rosso	
DE081	PE	Trasparente	



Valvola a Spillo per Montaggio In Linea

- In ottone. (*) disponibile fino ad esaurimento scorte.

CODICE	ATTACCHI PER TUBO	
DE098 (*)	1/4"	
DE098A (*)	3/8"	



Inserto per tubo flessibile 1/4"

- In materiale CELCON.

CODICE	
DE059	





Rubinetto Long Reach

- In ottone cromato;
- Con attacco per tubazione 1/4";
- Completi di kit di fissaggio;
- Lunghezza del tubo filettato 50 mm.

CODICE	
DE037	

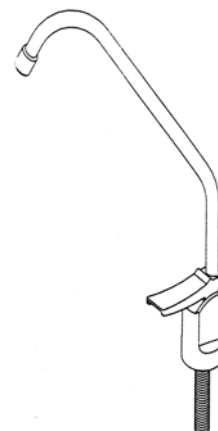

Rubinetto a Lavello Quarter-Turn

- In metallo e plastica cromato;
- Con attacco per tubazione 1/4";
- Completo di kit fissaggio;
- Con lunghezza tubo filettato 71 mm;
- Materiali a contatto del fluido idonei per l'uso con acqua potabile;
- Conforme ai requisiti dello standard NSF/ANSI 61.

CODICE	
DE116	



Rubinetto con Erogatore Acqua Trattata

- Monoblocco in ottone cromato;
- Con beccucci orientabili;
- Con attacchi acqua calda e fredda 1/2" con valvole intercettazione;
- Con attacco acqua trattata 1/4" tubazione;
- Completo di kit di installazione.

CODICE	
DE087	

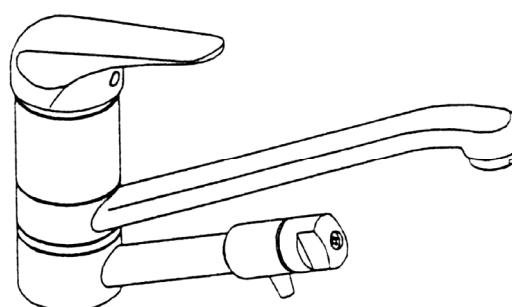



Manometro

- Taratura di pressione 0 ÷ 10 bar;
- Con attacco 1/8" M;
- Con diametro pari a 25 mm.

CODICE	
DE077	



Raccordo a 3 Vie Portamanometro

- In materiale plastico;
- Con attacchi 1/8" F x 1/8" M x 1/4" tubo.

CODICE	
DE078	

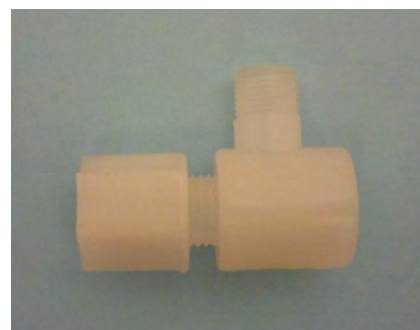

Check Valve in Linea

- In materiale plastico;
- Attacco rapido per tubo 1/4".

CODICE	
DE089	



Contenitori in Plastica MD, DD e TD a Due Pezzi, con Attacchi In-Out ¼" per Filtri a Cartuccia



CODICE
FBMD1002T



CODICE
FBMD1002W



CODICE
FBDD1002W



CODICE
FBTD1002W

- Prodotti nell'Unione Europea (Italia);
- Ideali per sistemi osmosi inversa e filtrazione domestici;
- Adatti per cartucce filtranti standard di lunghezza 10"
- Altezza totale 325 mm;
- Teste staffabili singole, doppie e triple in PP rinforzato di colore bianco;
- Vaso in PET trasparente o di colore bianco, O-ring in EPDM;
- Attacchi ingresso-uscita ¼" NPT F;
- Completi di valvola di sfiato;
- Pressione di esercizio massima pari a 8 bar;
- Range temperatura di esercizio da 4 a 45°C;
- Conformi al D.M. n.174/2004 per materiali idonei al contatto con acque destinate al consumo umano;
- Conformi al D.M. n.25/2012 "Disposizioni tecniche concernenti apparecchiature finalizzate al trattamento dell'acqua destinata al consumo umano";
- Conformi alla certificazione sanitaria ACS (per la Francia);
- Abbinabili alle sotto riportate staffe singole doppie o triple (queste ultime ideali anche per l'installazione 2+1), complete di viti per il fissaggio.

CODICE	MODELLO	TESTA	COLORE DEL VASO	INGOMBRO TESTE (mm)	
FBMD1002T	MD1002T	Singola	Trasparente	122	
FBMD1002W	MD1002W	Singola	Bianco	122	
FBDD1002W	DD1002W	Doppia	Bianco	228	
FBTD1002W	TD1002W	Tripla	Bianco	336	

Accessori

CODICE	DESCRIZIONE	
FBMDR11	CHIAVE IN PLASTICA PER FILTRI MD	
FBMDR22	STAFFA SINGOLA BIANCA IN PLASTICA PER FILTRI MD E MT COMPLETA DI VITI	
FBMDR24	STAFFA DOPPIA BIANCA PER FILTRI DD E DT COMPLETA DI VITI	
FBMDR26	STAFFA TRIPLA BIANCA PER FILTRI TD E TT COMPLETA DI VITI	

Flow Restrictor Linear Type



- Sistema di Regolazione Flusso a capillare per inserimento su tubo diametro 1/4" (Øe=6,35 mm);
- Fornito in lunghezza standard 200 mm e modificabile secondo necessità come da grafico allegato;
- Materiali inserto e tubo capillare rispettivamente in PP e PE;
- Pressione di esercizio da 2 a 8 bar.

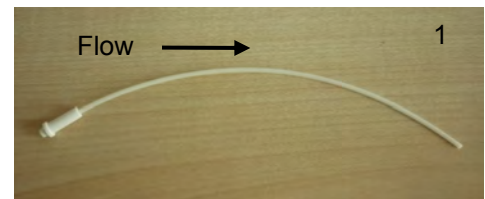

ITEM	DESCRIZIONE	CODICE	
1	FLOW RESTRICTOR LINEAR TYPE; LG = 200 MM	DE122	
2	INSERTO FLOW RESTRICTOR FRT-14P	DE124	
3	TUBO CAPILLARE ROTOLO 25 M	DE125	
4	FLOW RESTRICTOR JACO DOPPIO INSERTO OPEN	DE123	

ATTENZIONE: è indispensabile che il taglio del capillare sia netto e il tubo perfettamente circolare (aiutarsi eventualmente con un punteruolo per ripristinare la forma circolare), in caso contrario il valore di portata può essere notevolmente alterato. Rispettare la direzione del flusso così come indicato nella foto 1.

Flow restrictor linear type

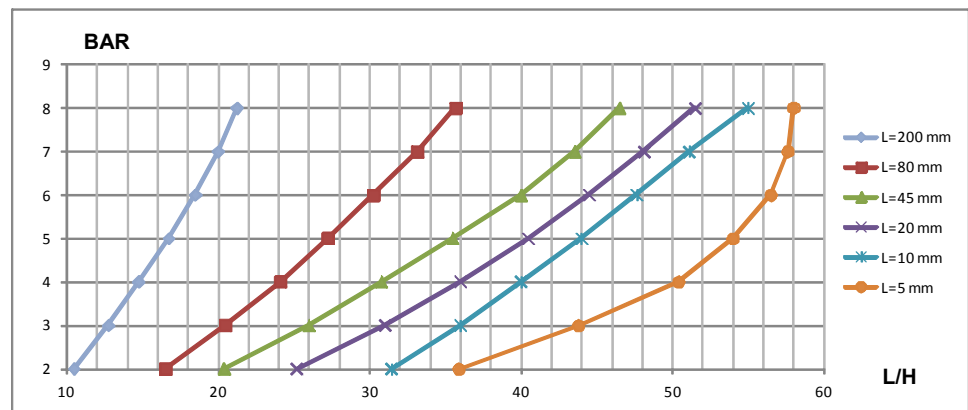

Flow restrictor Jaco 1/4" doppio inserto open

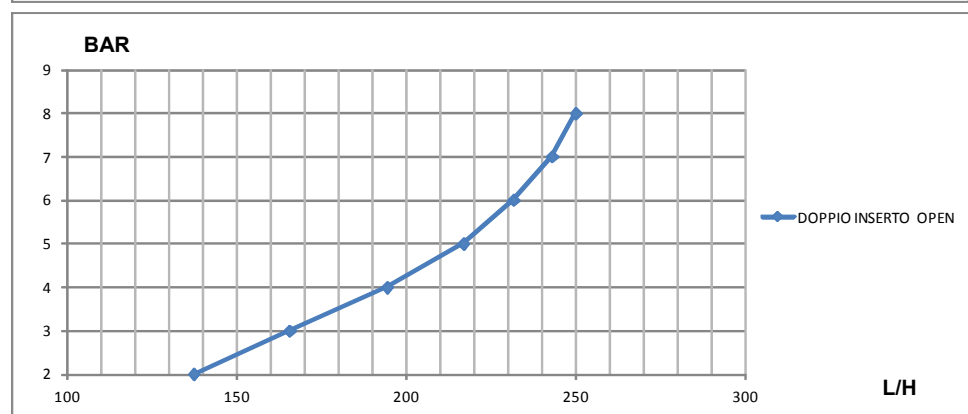



- Adatti per la realizzazione di sistemi domestici di filtrazione o osmosi inversa;
- Progettati per acqua, applicazioni alimentari e aria, ma possono essere anche usati con gas selezionati, vuoto e altri liquidi;
- Conformi al D.M. n.174/2004 per materiali idonei al contatto con acque destinate al consumo umano;
- Conformi alla certificazione sanitaria ACS (per la Francia);
- In resina acetalica di colore grigio, non tossica e approvata dalla NSF;
- Pressione massima 16 bar a 25°C.

RACCORDI DRITTI MASCHIO

CODICE	ATTACCO FILETTATO T NPT (pollici)	PER TUBAZIONE Ø D (pollici)	A (mm)	B (mm)	Ø E (mm)	H (mm)	L (mm)	
DH005	1/8"	1/4"	9,1	16,9	17,8	15,8	27,0	
DH006	1/4"	1/4"	13,2	16,9	17,8	15,8	27,0	
DH007	3/8"	1/4"	13,8	16,9	21,4	19,0	26,1	
DH012	1/8"	3/8"	9,1	20,2	23,0	20,6	30,4	
DH013	1/4"	3/8"	13,2	20,2	23,0	20,6	34,3	
DH014	3/8"	3/8"	13,8	20,2	23,0	20,6	29,9	

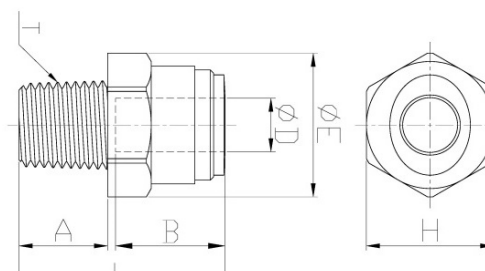

RACCORDI DRITTI FEMMINA

CODICE	ATTACCO FILETTATO T NPTF (pollici)	PER TUBAZIONE Ø D (pollici)	Ø P (mm)	A (mm)	B (mm)	Ø E (mm)	H (mm)	L (mm)	
DH021	1/8"	1/4"	15,5	11,5	16,9	19,0	17	30,9	
DH022	1/4"	1/4"	15,5	11,5	16,9	21,5	19	30,9	
DH023	1/4"	3/8"	20,0	11,5	20,2	21,5	19	34,2	

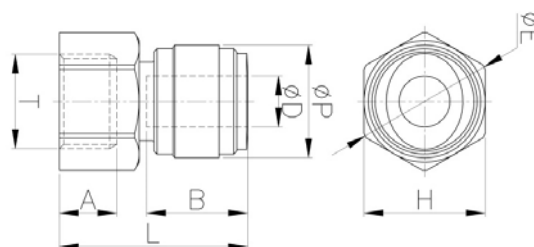



- Adatti per la realizzazione di sistemi domestici di filtrazione o osmosi inversa;
- Progettati per acqua, applicazioni alimentari e aria, ma possono essere anche usati con gas selezionati, vuoto e altri liquidi;
- Conformi al D.M. n.174/2004 per materiali idonei al contatto con acque destinate al consumo umano;
- Conformi alla certificazione sanitaria ACS (per la Francia);
- In resina acetilica di colore grigio, non tossica e approvata dalla NSF;
- Pressione massima 16 bar a 25°C.

RACCORDI GOMITI MASCHIO

CODICE	ATTACCO FILETTATO T NPT (pollici)	PER TUBAZIONE Ø D (pollici)	Ø P (mm)	A (mm)	B (mm)	E (mm)	H (mm)	L (mm)
DH033	1/8"	1/4"	15,5	9,1	16,9	26,4	11,0	25,6
DH034	1/4"	1/4"	15,5	13,2	16,9	31,9	11,0	27,0
DH035	3/8"	1/4"	15,5	13,8	16,9	32,7	11,0	28,9
DH038	1/4"	3/8"	20,0	13,2	20,2	35,2	14,3	31,8
DH039	3/8"	3/8"	20,0	13,8	20,2	35,8	14,3	33,9

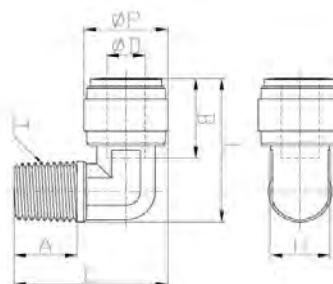

RACCORDI PASSAPARETE

CODICE	T	PER TUBAZIONE Ø D ₁ (pollici)	PER TUBAZIONE Ø D ₂ (pollici)	B ₁ (mm)	B ₂ (mm)	H ₁ (fixed)	H ₂ (mm)	L (mm)
DH052	M17	1/4"	1/4"	16,9	16,9	19	21	35,7
DH054	M24	3/8"	3/8"	20,2	20,2	24	25,5	42,4

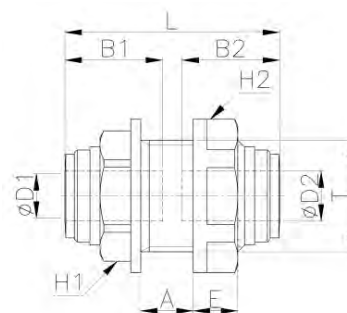



- Adatti per la realizzazione di sistemi domestici di filtrazione o osmosi inversa;
- Progettati per acqua, applicazioni alimentari e aria, ma possono essere anche usati con gas selezionati, vuoto e altri liquidi;
- Conformi al D.M. n.174/2004 per materiali idonei al contatto con acque destinate al consumo umano;
- Conformi alla certificazione sanitaria ACS (per la Francia);
- In resina acetilica di colore grigio, non tossica e approvata dalla NSF;
- Pressione massima 16 bar a 25°C.

RACCORDI A GOMITO CON CODOLO

CODICE	PER TUBAZIONE Ø D ₁ (pollici)	PER TUBAZIONE Ø D ₂ (pollici)	Ø P (mm)	A (mm)	B (mm)	E (mm)	L (mm)
DH063	1/4"	1/4"	15,5	21,0	16,9	34,8	25,1
DH065	3/8"	3/8"	20,0	24,8	20,2	43,2	31,4
DH067	3/8"	1/4"	17,6	22,5	17,5	38,3	27,7

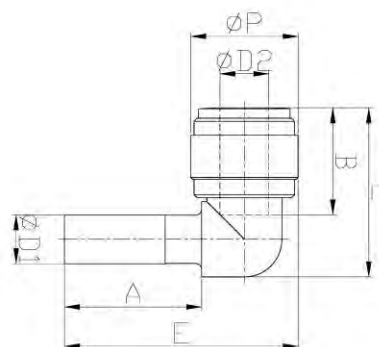

RACCORDI INTERMEDI DIRITTI

CODICE	PER TUBAZIONE Ø D ₁ (pollici)	PER TUBAZIONE Ø D ₂ (pollici)	B ₁ (mm)	B ₂ (mm)	Ø E (mm)	L (mm)
DH073	1/4"	1/4"	16,9	16,9	15,5	36,2
DH075	3/8"	3/8"	20,2	20,2	20,0	42,9
DH079	3/8"	1/4"	20,2	16,9	20,0	42,1

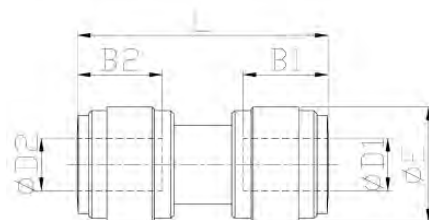



- Adatti per la realizzazione di sistemi domestici di filtrazione o osmosi inversa;
- Progettati per acqua, applicazioni alimentari e aria, ma possono essere anche usati con gas selezionati, vuoto e altri liquidi;
- Conformi al D.M. n.174/2004 per materiali idonei al contatto con acque destinate al consumo umano;
- Conformi alla certificazione sanitaria ACS (per la Francia);
- In resina acetalica di colore grigio, non tossica e approvata dalla NSF;
- Pressione massima 16 bar a 25°C.

RACCORDI INTERMEDI A GOMITO

CODICE	PER TUBAZIONE Ø D ₁ (pollici)	PER TUBAZIONE Ø D ₂ (pollici)	B ₁ (mm)	B ₂ (mm)	Ø E ₁ (mm)	Ø E ₂ (mm)	L (mm)	H (mm)	
DH083	1/4"	1/4"	16,9	16,9	15,5	15,5	28,8	28,8	
DH085	3/8"	3/8"	20,2	20,2	20,0	20,0	35,9	35,9	

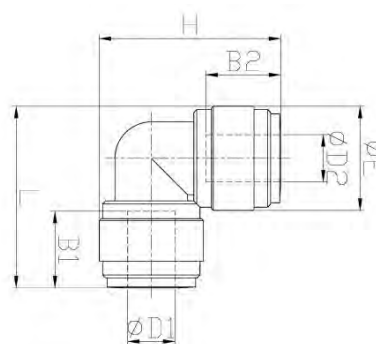

RACCORDI INTERMEDI A T

CODICE	PER TUBAZIONE Ø D ₁ (pollici)	PER TUBAZIONE Ø D ₂ (pollici)	PER TUBAZIONE Ø D ₃ (pollici)	B ₁ (mm)	B ₂ (mm)	B ₃ (mm)	Ø E (mm)	L (mm)	H (mm)	
DH093	1/4"	1/4"	1/4"	16,9	16,9	16,9	15,5	42,0	28,8	
DH095	3/8"	3/8"	3/8"	20,2	20,2	20,2	20,0	51,8	35,9	

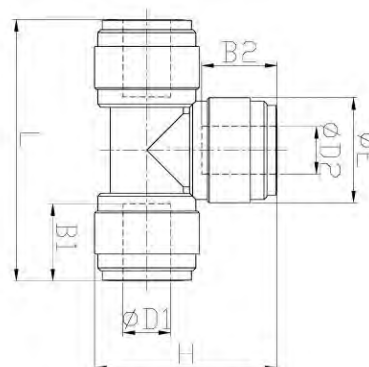



- Adatti per la realizzazione di sistemi domestici di filtrazione o osmosi inversa;
- Progettati per acqua, applicazioni alimentari e aria, ma possono essere anche usati con gas selezionati, vuoto e altri liquidi;
- Conformi al D.M. n.174/2004 per materiali idonei al contatto con acque destinate al consumo umano;
- Conformi alla certificazione sanitaria ACS (per la Francia);
- In resina acetalica di colore grigio, non tossica e approvata dalla NSF;
- Pressione massima 16 bar a 25°C.

RACCORDI INTERMEDI A Y

CODICE	PER TUBAZIONE Ø D ₁ (pollici)	PER TUBAZIONE Ø D ₂ (pollici)	B ₁ (mm)	B ₂ (mm)	Ø P ₁ (mm)	Ø P ₂ (mm)	L (mm)	J (mm)	C (mm)
DH103	1/4"	1/4"	16,9	16,9	15,5	15,5	38,8	15,5	3,3
DH105	3/8"	3/8"	20,2	20,2	20,0	20,0	46,4	20,0	4,5

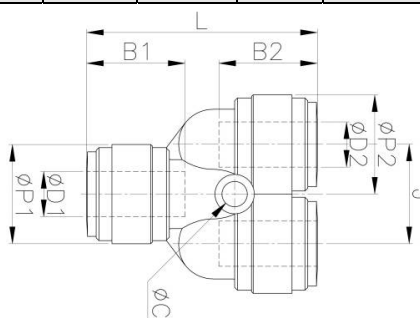

RACCORDI A T GIREVOLI MASCHIO NPTF

CODICE	ATTACCO FILETTATO T NPT (pollici)	PER TUBAZIONE Ø D (pollici)	Ø P (mm)	A (mm)	B (mm)	E (mm)	H (mm)	L (mm)
DH112	1/4"	1/4"	15,5	13,2	16,9	21,0	17,46	36,9
DH114	3/8"	3/8"	20,0	13,0	20,2	25,9	21,4	41,8

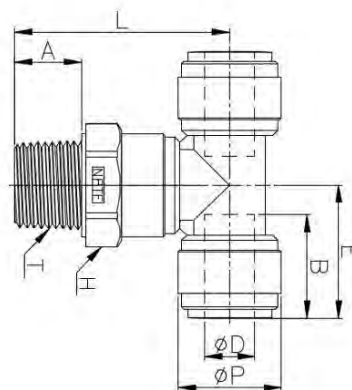



- Adatti per la realizzazione di sistemi domestici di filtrazione o osmosi inversa;
- Progettati per acqua, applicazioni alimentari e aria, ma possono essere anche usati con gas selezionati, vuoto e altri liquidi;
- Conformi al D.M. n.174/2004 per materiali idonei al contatto con acque destinate al consumo umano;
- Conformi alla certificazione sanitaria ACS (per la Francia);
- In resina acetilica di colore grigio, non tossica e approvata dalla NSF;
- Pressione massima 16 bar a 25°C.

RACCORDI A T LATERALE GIREVOLE MASCHIO NPTF

CODICE	ATTACCO FILETTATO T NPT (pollici)	PER TUBAZIONE Ø D (pollici)	Ø P (mm)	A (mm)	B (mm)	E (mm)	H (mm)	L ₁ (mm)	L ₂ (mm)
DH122	1/4"	1/4"	15,5	13,2	16,9	21,0	17,46	36,9	57,9
DH124	3/8"	3/8"	20,0	13,0	20,2	25,9	21,4	41,8	67,7

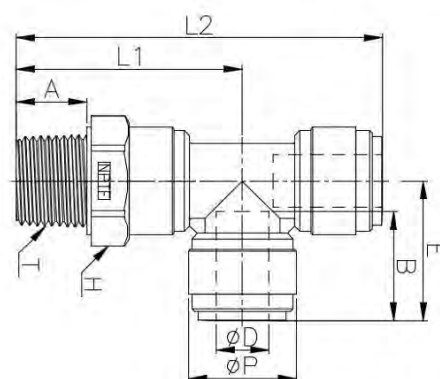

VALVOLE DI NON RITORNO

CODICE	PER TUBAZIONE Ø D (pollici)	Ø P (mm)	B (mm)	L (mm)
DH131	1/4"	15,5	16,1	45,5
DH133	3/8"	20,0	19,5	57,8

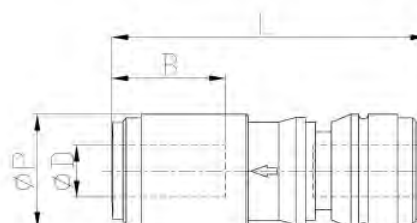



- Adatti per la realizzazione di sistemi domestici di filtrazione o osmosi inversa;
- Progettati per acqua, applicazioni alimentari e aria, ma possono essere anche usati con gas selezionati, vuoto e altri liquidi;
- Conformi al D.M. n.174/2004 per materiali idonei al contatto con acque destinate al consumo umano;
- Conformi alla certificazione sanitaria ACS (per la Francia);
- In resina acetalica di colore grigio, non tossica e approvata dalla NSF;
- Pressione massima 16 bar a 25°C.

VALVOLE MANUALI A DUE VIE

CODICE	PER TUBAZIONE Ø D ₁ (pollici)	PER TUBAZIONE Ø D ₂ (pollici)	B ₁ (mm)	B ₂ (mm)	Ø P ₁ (mm)	Ø P ₂ (mm)	L ₁ (mm)	L ₂ (mm)	E (mm)	Ø C (mm)
DH141	1/4"	1/4"	16,1	16,1	15,5	15,5	9,5	34,5	51,7	19,2
DH143	3/8"	3/8"	20,2	20,2	20,0	20,0	12,5	42,3	63,2	24,2

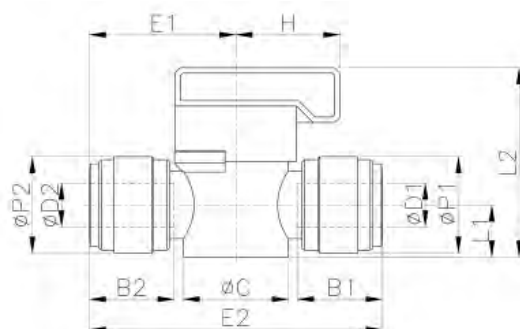

REGOLATORI DI FLUSSO PASSAPARETE IN LINEA

CODICE	PER TUBAZIONE Ø D (pollici)	T	Ø P (mm)	A (mm)	B (mm)	E ₁ (mm)	E ₂ (mm)	H (mm)	L min (mm)	L max (mm)
DH157	1/4"	M12	15,5	5,0	16,9	22,2	44,4	16	45,5	50,4
DH158	3/8"	M15	20,0	6,0	19,8	26,1	52,1	19	52,7	58,4

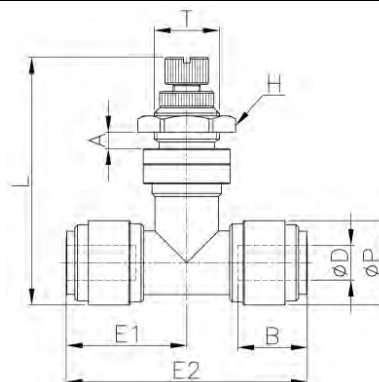



- Adatti per la realizzazione di sistemi domestici di filtrazione o osmosi inversa;
- Progettati per acqua, applicazioni alimentari e aria, ma possono essere anche usati con gas selezionati, vuoto e altri liquidi;
- Conformi al D.M. n.174/2004 per materiali idonei al contatto con acque destinate al consumo umano;
- Conformi alla certificazione sanitaria ACS (per la Francia);
- In resina acetilica di colore grigio, non tossica e approvata dalla NSF;
- Pressione massima 16 bar a 25°C.

REGOLATORI DI FLUSSO IN LINEA

CODICE	PER TUBAZIONE Ø D (pollici)	Ø P (mm)	B (mm)	L min (mm)	L max (mm)	E 1 (mm)	E 2 (mm)
DH167	1/4"	15,5	16,9	45,5	42,7	22,2	44,4
DH168	3/8"	20,0	19,8	57,8	49,7	26,1	52,1

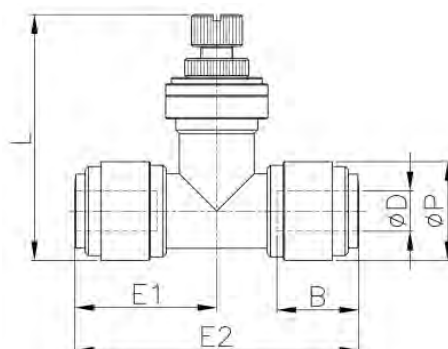

CLIP DI BLOCCAGGIO

CODICE	PER TUBAZIONE Ø D (pollici)	Ø C (mm)	E (mm)	L (mm)	H (mm)	J (mm)	K (mm)
DH193	06 - 1/4"	8,0	11,6	11,6	3,1	6,4	1,3
DH195	10 - 3/8"	11,8	16,0	16,4	3,4	9,2	1,4

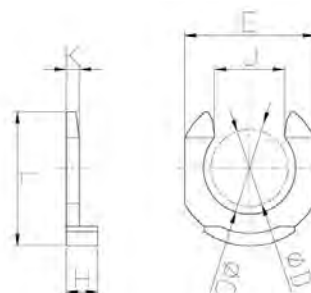

Sistema a osmosi inversa PRF-RO



- Perfetto per l'utilizzo domestico, ma anche per molteplici applicazioni commerciali;
- Compatto e affidabile, soddisfa al meglio i requisiti delle imprese di piccole e medie dimensioni;
- Non occorre alcun serbatoio di accumulo;
- Funziona con la pressione della rete idrica;
- Non necessita di pompe, né di elettricità;
- Grande facilità di installazione mediante attacchi ad innesto rapido;
- Minima manutenzione (sostituzione delle cartucce facile e veloce);
- Costituito da n.1 Pre-filtro a carbone attivo, n.2 membrane osmotiche RO e n.1 Post-filtro a carbone attivo.



CONDIZIONI DI ESERCIZIO	MINIMO	MASSIMO
Pressione in ingresso	2,8 bar (40 psi)	5,5 bar (80 psi)
Temperatura in ingresso (°C)	4	38
TDS in ingresso (mg/l)	50	2.000
Durezza in ingresso (°F)	0	20
Cloro in ingresso (mg/l)	0	1,0
Ferro in ingresso (mg/l)	0	0,1
Manganese in ingresso (mg/l)	0	0,05

Reiezione salina minimo 90%, media 93%

DIMENSIONI DI TUBI/RACCORDI	
Tubo d'ingresso (trasparente)	1/2"
Tubo del concentrato (di colore nero)	3/8"
Tubo del permeato (di colore blu)	3/8"
Tubo di scarico (di colore rosso)	1/2"
Attacco tubo di scarico	3/8" o 1/2"
Post-filtro a carbone attivo	Attacchi a disinnesto rapido da 3/8"

Dati prestazionali relativi a filtri/membrane:

Tipo di filtro	Lunghezza (mm)	Diametro (mm)	Portata (lpm)	Portata (gpm)	Durata media (mesi)
Pre-filtro a carbone attivo	432	74	14,20	3,75	6 (o 19.000 litri)
Elemento RO	476	80	(*) 0,95	(*) 0,25	24 ÷ 48
Post-filtro a carbone attivo	254	51	2,80	0,75	6 (o 19.000 litri)

(*) @ 3,44 bar T=25°C 750 mg/l NaCl 25% recupero 1 ppm Cloro inlet

Codice	P. N.	Descrizione
DE904	4000462	Kit R.O. PRF-RO System con rubinetto
DE906 (**)	4000575	Kit R.O. PRF-RO System senza rubinetto

(**) disponibile fino ad esaurimento scorte.

Sistema a osmosi inversa PRF-RO



Dimensioni d'ingombro in pollici (mm):

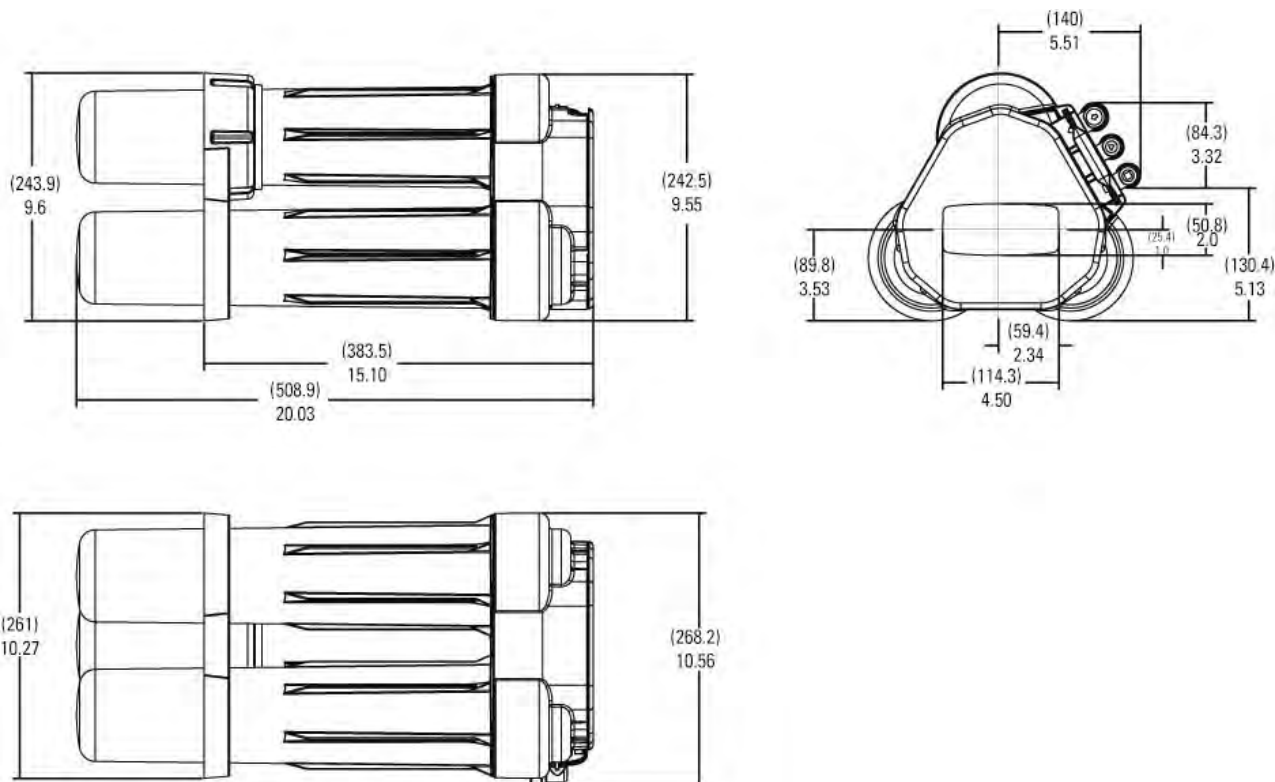

Prestazioni – Caratteristiche di portata (*)

Basato su 750 ppm TDS acqua in ingresso

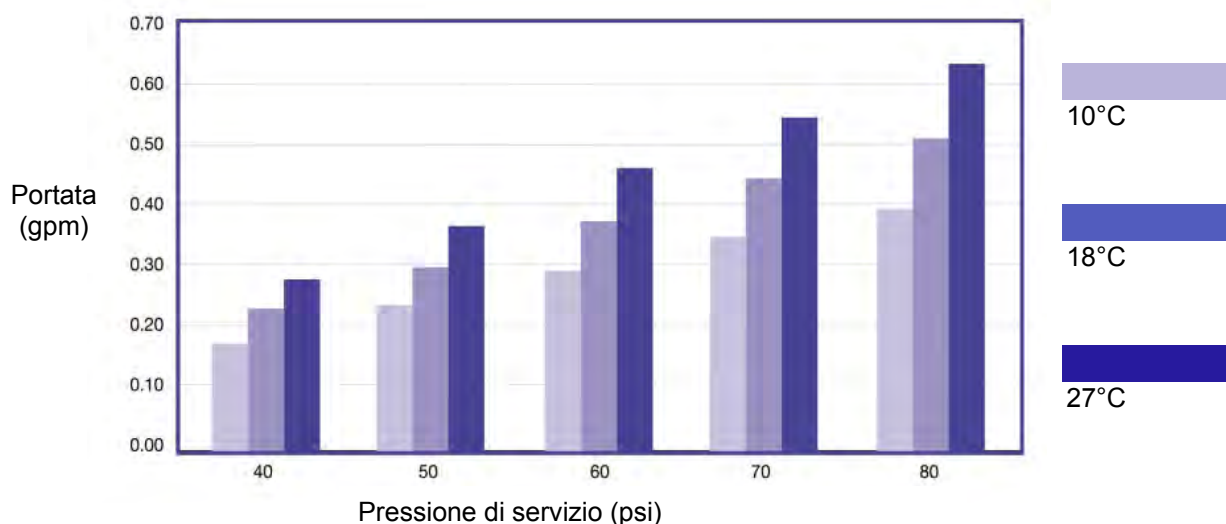

Regolazione portata basata su TDS

(*) Valore di portata stimato sulla base dei dati ottenuti nelle prove interne del produttore.

Le prestazioni effettive potrebbero variare.

Sistema a osmosi inversa PRF-RO



Ricambi del Sistema a osmosi inversa PRF-RO:

Codice	P. N.	Descrizione	
DE920	4000569	Membrana PRF-RO	
DE923	3038333	Cartuccia prefiltro a carbone	
DE924	1266690	Cartuccia prefiltro sediment 10 micron	
DE926	255526-09	In-line postfiltro a carbone	
DE930	1239705	Vaso ricambio	
DE932	1240326	O-ring per vaso	
DE935	4000445	Testata completa PRF-RO	
DE937	3038021	Spalla di supporto PRF-RO	
DE938	1240564	Kit raccordo di scarico con fascette	
DE941	3038026	Piastra di sicurezza fissaggio raccordi PRF-RO	
DE942	3020487	Rubinetto con air-gap	
DE945	4000330	Kit raccordi di collegamento PRF-RO	
DE946	1255736	Kit tubi di collegamento	
DE950 (*)	1240620	Rotolo 152 m tubo 3/8" nero	
DE951 (*)	1240621	Rotolo 152 m tubo 3/8" blu	
DE952 (*)	1240622	Rotolo 76 m tubo 1/2" trasparente	
DE953 (*)	1240623	Rotolo 76 m tubo 1/2" rosso	
DE954	1264462	Raccordo gomito concentrato 3/8" nero	
DE955	12400117	Raccordo gomito alimento 1/2" bianco	
DE956	12400118	Raccordo gomito permeato 3/8" blu	
DE960	3002791	Misuratore temperatura	
DE961	4000454	Retro fit kit PRF-RO	

(*) N.D. = Non Disponibile.