



Residential R.O. components



1,8" Residential CSM Membranes



RESIDENTIAL

RO elements for residential use (1.8 inch diameter)

CSM[®]

SPECIFICATIONS:

General Features

Model Name	Permeate Flow Rate GPD (L/day)	Salt Rejection %
RE1810-30	30 (114)	98.0%
RE1810-50	50 (189)	98.0%
RE1812-35	35 (132)	98.0%
RE1812-50	50 (189)	98.0%
RE1812-60	60 (227)	98.0%
RE1812-80	80 (303)	98.0%

- The stated product performance is based on data taken after 30 minutes of operation at the following test conditions:
 - 200 mg/L NaCl solution at 60 psig (0.41 MPa) applied pressure
 - 15% recovery
 - 77 °F (25 °C)
 - pH 6.5–7.0
- Dry type elements are vacuum leak tested using the San Diego Protocol.
- Permeate flow rate for each element may vary but will be no more than 15%.
- Dry elements are packaged in a polyethylene bag
 - α Wet elements are packaged in a polyethylene bag containing SB(4g/L) + HCl(0.51g/L) solution.

Membrane type: Thin-Film Composite
Membrane material: Polyamide (PA)
Element configuration: Spiral-Wound, Tape Wrapping

Dimensions

Model Name	A	B	C	D	E
RE1810-30	0.67 (17mm)	0.55 (14mm)	10.08 (256mm)	0.98 (25mm)	1.77 (45mm)
RE1810-50					
RE1812-35	0.67 (17mm)	0.87 (22mm)	11.73 (298mm)	0.98 (25mm)	1.77 (45mm)
RE1812-50					
RE1812-60					
RE1812-80					

*All measurement are in inches

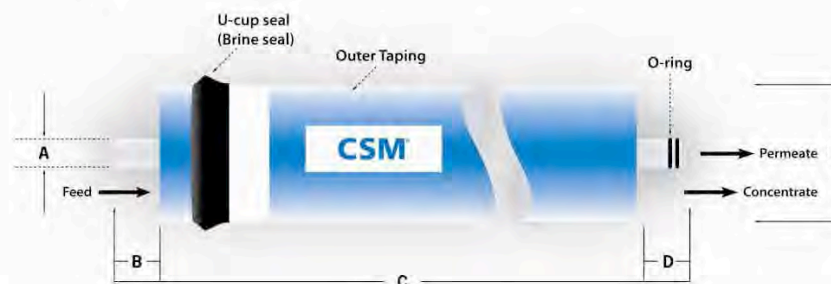

1,8" Residential CSM Membranes



These model names are tested and certified under NSF/ANSI standard 58, material requirement only (excluding RE1810-30)

RESIDENTIAL
RO elements for residential use (1.8 inch diameter)

CSM[®]

APPLICATION DATA:

Operating Limits

· Max. Operating Pressure	125 psi (0.86 MPa)
· Max. Feed Flow Rate	2 gpm (0.45 m ³ /hr)
· Max. Operating Temperature	113 °F (45 °C)
· Operating pH Range	2.0–11.0
· Max. Turbidity	1.0 NTU
· Max. SDI (15 min)	5.0
· Max. Chlorine Concentration	< 0.1 mg/L

The information provided in this document is solely for informative purposes. It is the user's responsibility to ensure the appropriate usage of this product. Woongjin Chemical assumes no obligation, liability or damages incurred for the misuse of the product or for the information provided in this document. This document does not express or implies any warranty as to the merchantability or fitness of the products.

GENERAL HANDLING PROCEDURES

- Elements contained in the boxes must be kept dry at room temperature (7–32°C; 40–95°F) and should not be stored in direct sunlight. If the polyethylene bag is damaged, a new preservative solution (sodium bisulfite) must be added and air-tight sealed to prevent drying and biological growth.
- Permeate from the first hour of operation should be discarded to flush out the preservative solution.
- Elements should be immersed in a preservative solution during storage, shipping and system shutdowns to prevent biological growth and freezing. The standard storage solution contains 1% by weight sodium bisulfite or sodium metabisulfite (food grade). For short term storage (i.e. one week or less) 1% by weight sodium metabisulfite solution is adequate for preventing biological growth.
- Keep elements moist at all times after initial wetting.
- Only use chemicals compatible with the membrane elements and components. Use of such chemicals may void the element limited warranty.
- Permeate pressure must always be equal or less than the feed/concentrate pressure. Damage caused by permeate back pressure voids the element limited warranty.

REF.	MODEL NAME	
	RE1810-30	
	RE1812-35	
MCRE1812-50	RE1812-50	
MCRE1812-60	RE1812-60	
MCRE1812-80	RE1812-80	

1,8" Residential CSM Membranes



RESIDENTIAL

High recovery & High rejection RO element for residential use

CSM[®]

SPECIFICATIONS:

General Features

Model Name	Permeate Flow Rate GPD (L/day)	Salt Rejection (%)	Pressure / Recovery
RE1812-HR+	80 (302.8)	99.0 (min. 97.5)	60psig / 30%
	105 (397.5)	96.0 (min. 95.0)	80psig / 60%

- The stated product performance is based on data taken after 30 minutes of operation at the following test conditions:
 - 200 mg/L NaCl solution , 77 °F (25 °C), pH 6.5–7.0
- All elements are vacuum leak tested using the CSM integrity test.
- Permeate flow rate for each element may vary +15/ -15%.
- Elements can be supplied as dry or wet-type. Wet-tested elements are soaked in a preservative solution (1.0% food grade SBS) and vacuum sealed in a poly bag. All elements are individually boxed.

Membrane type: Thin-Film Composite
Membrane material: Polyamide (PA)
Element configuration: Spiral-Wound, Tape Wrapping

Dimensions

Model Name	A	B	C	D	E
RE1812-HR+	0.67 inch (17mm)	0.87 inch (22 mm)	11.73 inch (298 mm)	0.87 inch (22 mm)	1.77 inch (45 mm)

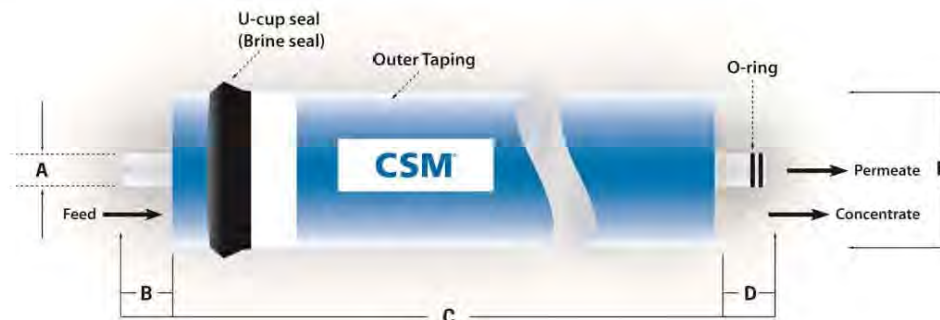

1,8" Residential CSM Membranes



RESIDENTIAL

High recovery & High rejection RO element for residential use

CSM®

APPLICATION DATA:

Operating Limits

· Max. Operating Pressure	150 psi (1.03 MPa)
· Max. Feed Flow Rate	2 gpm (0.45 m ³ /hr)
· Max. Operating Temperature	113 °F (45 °C)
· Operating pH Range	2.0–11.0
· Max. Turbidity	1.0 NTU
· Max. SDI (15 min)	3.0
· Max. Chlorine Concentration	< 0.1 mg/L

The information provided in this document is solely for informative purposes. It is the user's responsibility to ensure the appropriate usage of this product. Toray Chemical Korea Inc. assumes no obligation, liability or damages incurred for the misuse of the product or for the information provided in this document. This document does not express or implies any warranty as to the merchantability or fitness of the product.

GENERAL HANDLING PROCEDURES

- Elements contained in the boxes must be kept dry at room temperature (7–32°C; 40–95°F) and should not be stored in direct sunlight.
- When running the system for the first time, the permeate should be discarded continuously at least 1 hour.
- Keep elements moistly at all times after initial wetting.
- Elements should be immersed in a preservative solution during storage, shipping and system shutdowns to prevent biological growth and freezing. The standard storage solution contains 1% by weight sodium bisulfite or sodium metabisulfite (food grade). For short term storage (i.e. one week or less) 1% by weight sodium metabisulfite solution is adequate for preventing from biological growth.
- Keep elements moistly at all times after initial wetting.
- Only use chemicals compatible with the membrane elements and components. Use of such chemicals may void the element limited warranty. For additional information on use of approved chemicals please contact your nearest CSM representative.
- Permeate pressure must always be equal or less than the feed/concentrate pressure. Damage caused by permeate back pressure voids the element limited warranty.

REF.	MODEL NAME	
MCRE1812-HR+	RE1812-HR+	

2" - 2,8" Residential CSM Membranes



RESIDENTIAL

RO elements for residential use (2.0 and 2.8 inch diameters)

CSM®

SPECIFICATIONS:

General Features

Model Name	Permeate Flow Rate GPD (L/day)	Salt Rejection (%)
RE2012-100	100 (397)	98.0
RE2812-300	300 (1,136)	96.0

- The stated product performance is based on data taken after 30 minutes of operation at the following test conditions:
 - 200 mg/L NaCl solution at 60 psig (0.41 MPa) applied pressure
 - 15% recovery
 - 77 °F (25 °C)
 - pH 6.5–7.0
- Minimum salt rejection is 96.0%.
- Permeate flow rate for each element may vary but will be no more than 15%.
- Wet elements are packaged in a polyethylene bag containing 1.0% SBS (sodium bisulfite) solution.

Membrane type: Thin-Film Composite
Membrane material: Polyamide (PA)
Element configuration: Spiral-Wound, Tape Wrapping

Dimensions

Model Name	A	B	C	D	E
RE2012-100	0.67 (17)	0.5 (12)	11.7 (298)	0.9 (23)	1.9 (48)
RE2812-300	0.67 (17)	0.9 (22)	11.7 (298)	0.9 (22)	2.9 (74)

*All measurements are in inches (millimeters)



2" - 2,8" Residential CSM Membranes



RESIDENTIAL

RO elements for residential use (2.0 and 2.8 inch diameters)

CSM®

APPLICATION DATA:

Operating Limits

· Max. Operating Pressure	125 psi (0.86 MPa)
· Max. Feed Flow Rate	2 gpm (0.45 m ³ /hr)
· Max. Operating Temperature	113 °F (45 °C)
· Operating pH Range	2.0–11.0
· Max. Turbidity	1.0 NTU
· Max. SDI (15 min)	5.0
· Max. Chlorine Concentration	< 0.1 mg/L

The information provided in this document is solely for informative purposes. It is the user's responsibility to ensure the appropriate usage of this product. Toray Chemical Korea Inc. assumes no obligation, liability or damages incurred for the misuse of the product or for the information provided in this document. This document does not express or implies any warranty as to the merchantability or fitness of the product.

GENERAL HANDLING PROCEDURES

- Elements contained in the boxes must be kept dry at room temperature (7–32°C; 40–95°F) and should not be stored in direct sunlight. If the polyethylene bag is damaged, a new preservative solution (sodium bisulfite) must be added and air-tight sealed to prevent drying and biological growth.
- When running the system for the first time, the permeate should be discarded continuously at least 1 hour.
- Keep elements moistly at all times after initial wetting.
- Elements should be immersed in a preservative solution during storage, shipping and system shutdowns to prevent biological growth and freezing. The standard storage solution contains 1% by weight sodium bisulfite or sodium metabisulfite (food grade). For short term storage (i.e. one week or less) 1% by weight sodium metabisulfite solution is adequate for preventing from biological growth.
- Only use chemicals compatible with the membrane elements and components. Use of such chemicals may void the element limited warranty.
- Permeate pressure must always be equal or less than the feed/concentrate pressure. Damage caused by permeate back pressure voids the element limited warranty.

REF.	MODEL NAME	
MCRE2012-100	RE2012-100	
MCRE2812-300	RE2812-300	

2" Residential CSM Membranes



SPECIFICATIONS:

General Features

Model Name	Active Membrane Area ft ² (m ²)	Permeate Flow Rate GPD (L/day)	Salt Rejection (%)
RE2012-150	6.4 (0.59)	150 (567.8)	98.0

1. The stated product performance is based on data taken after 30 minutes of operation at the following test conditions:

- 200 mg/L NaCl solution at 60 psig (0.41 MPa) applied pressure
- 15% recovery
- 77 °F (25 °C)
- pH 6.5–7.0

2. Minimum salt rejection is 96.0%.

3. Dry type elements are vacuum leak tested using the CSM integrity test.

4. Permeate flow rate for each element may vary but will be no more than 15%.

5. Dry elements are packaged in a polyethylene bag.

Membrane type:	Thin-Film Composite
Membrane material:	Polyamide (PA)
Element configuration:	Spiral-Wound, Tape Wrapping

Dimensions

Model Name	A	B	C	D	E
RE2012-150	0.67 (17)	0.5 (12)	11.7 (298)	0.9 (23)	1.9 (48)

*All measurements are in inches (millimeters).



2" Residential CSM Membranes



RESIDENTIAL

High flux RO elements for residential use

CSM[®]

APPLICATION DATA:

Operating Limits

· Max. Operating Pressure	150 psi (1.03 MPa)
· Max. Feed Flow Rate	2 gpm (0.45 m ³ /hr)
· Max. Operating Temperature	113 °F (45 °C)
· Operating pH Range	2.0–11.0
· Max. Turbidity	1.0 NTU
· Max. SDI (15 min)	5.0
· Max. Chlorine Concentration	< 0.1 mg/L

The information provided in this document is solely for informative purposes. It is the user's responsibility to ensure the appropriate usage of this product. Toray Chemical Korea Inc. assumes no obligation, liability or damages incurred for the misuse of the product or for the information provided in this document. This document does not express or imply any warranty as to the merchantability or fitness of the product.

GENERAL HANDLING PROCEDURES

- Elements contained in the boxes must be kept dry at room temperature (7–32°C; 40–95°F) and should not be stored in direct sunlight.
- When running the system for the first time, the permeate should be discarded continuously at least 1 hour.
- Keep elements moistly at all times after initial wetting.
- Elements should be immersed in a preservative solution during storage, shipping and system shutdowns to prevent biological growth and freezing. The standard storage solution contains 1% by weight sodium bisulfite or sodium metabisulfite (food grade). For short term storage (i.e. one week or less) 1% by weight sodium metabisulfite solution is adequate for preventing from biological growth.
- Only use chemicals compatible with the membrane elements and components. Use of such chemicals may void the element limited warranty. For additional information on use of approved chemicals please contact your nearest CSM representative.
- Permeate pressure must always be equal or less than the feed/concentrate pressure. Damage caused by permeate back pressure voids the element limited warranty.

REF.	MODEL NAME	
MCRE2012-150	RE2012-150	

2" Residential CSM Membranes



SPECIFICATIONS:

General Features

Model Name	Permeate Flow Rate GPD (L/day)	Salt Rejection (%)	Pressure / Recovery
RE2012-400	400 (1514)	96.0 (min. 95.0)	80psig / 30%

1. The stated product performance is based on data taken after 30 minutes of operation at the following test conditions:

- 200 mg/L NaCl solution , 77 °F (25 °C), pH 6.5–7.0

2. Wet type elements are vacuum leak tested using the CSM integrity test.
3. Permeate flow rate for each element may vary but will be no more than 15%.
4. Wet elements are packaged in a polyethylene bag containing 1.0% SBS (sodium bisulfite) solution.

Membrane type:	Thin-Film Composite
Membrane material:	Polyamide (PA)
Element configuration:	Spiral-Wound, Tape Wrapping

Dimensions

Model Name	A	B	C	D	E
RE2012-400	0.67 (17mm)	0.5 (12mm)	11.73 (298mm)	0.91 (23mm)	1.89 (48mm)

*All measurements are in inches (millimeters).

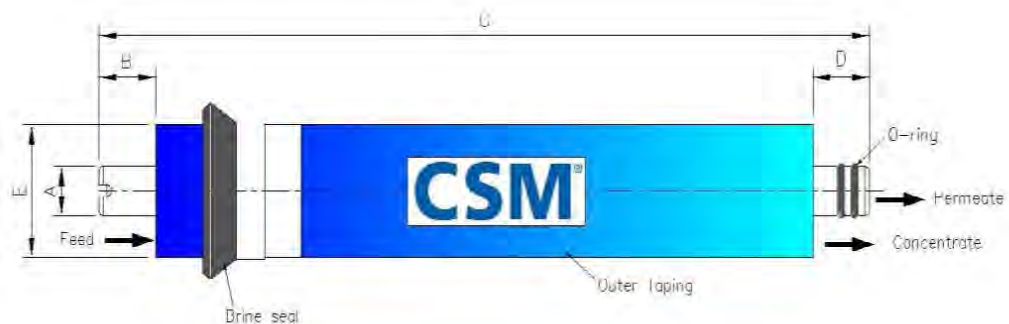

2" Residential CSM Membranes



RESIDENTIAL

High recovery & High rejection RO element for residential use

CSM®

APPLICATION DATA:

Operating Limits

· Max. Operating Pressure	150 psi (1.03 MPa)
· Max. Feed Flow Rate	2 gpm (0.45 m ³ /hr)
· Max. Operating Temperature	113 °F (45 °C)
· Operating pH Range	2.0–11.0
· Max. Turbidity	1.0 NTU
· Max. SDI (15 min)	3.0
· Max. Chlorine Concentration	< 0.1 mg/L

The information provided in this document is solely for informative purposes. It is the user's responsibility to ensure the appropriate usage of this product. Toray Chemical Korea Inc. assumes no obligation, liability or damages incurred for the misuse of the product or for the information provided in this document. This document does not express or implies any warranty as to the merchantability or fitness of the product.

GENERAL HANDLING PROCEDURES

- Elements contained in the boxes must be kept dry at room temperature (7–32°C; 40–95°F) and should not be stored in direct sunlight.
- When running the system for the first time, the permeate should be discarded continuously at least 1 hour.
- Keep elements moistly at all times after initial wetting.
- Elements should be immersed in a preservative solution during storage, shipping and system shutdowns to prevent biological growth and freezing. The standard storage solution contains 1% by weight sodium bisulfite or sodium metabisulfite (food grade). For short term storage (i.e. one week or less) 1% by weight sodium metabisulfite solution is adequate for preventing from biological growth.
- Keep elements moistly at all times after initial wetting.
- Only use chemicals compatible with the membrane elements and components. Use of such chemicals may void the element limited warranty. For additional information on use of approved chemicals please contact your nearest CSM representative.
- Permeate pressure must always be equal or less than the feed/concentrate pressure. Damage caused by permeate back pressure voids the element limited warranty.

REF.	MODEL NAME	
MCRE2012-400	RE2012-400	

2" Residential CSM Membranes



RESIDENTIAL

Low pressure grade RO elements for residential use

CSM[®]

SPECIFICATIONS:

General Features

Model Name	Permeate Flow Rate GPD (L/day)	Salt Rejection %
RE2010-LP	30 (114)	93.0%
RE2012-LP	50 (189)	93.0%
RE2012-LPF	60 (227)	93.0%

- The stated product performance is based on data taken after 30 minutes of operation at the following test conditions:
 - 100 mg/L NaCl solution at 20 psig (0.14 MPa) applied pressure
 - 15% recovery
 - 77 °F (25 °C)
 - pH 6.5–7.0
- Dry type elements are vacuum leak tested using the San Diego Protocol.
- Permeate flow rate for each element may vary but will be no more than 15%.
- Dry elements are packaged in a polyethylene bag
 - Wet elements are packaged in a polyethylene bag containing SB(4g/L) + HCl(0.5lg/L) solution.

Membrane type: Thin-Film Composite
Membrane material: Polyamide (PA)
Element configuration: Spiral-Wound, Tape Wrapping

Dimensions

Model Name	A	B	C	D	E
RE2010-LP	0.67	0.55	10.08	0.98	1.91
RE2012-LP	0.67	0.47	11.73	0.91	1.91
RE2012-LPF	0.67	0.47	11.73	0.91	1.91

*All measurement are in inches

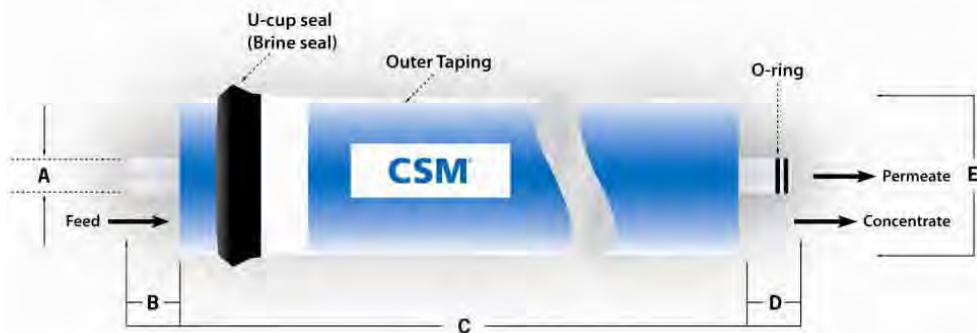



RESIDENTIAL

Low pressure grade RO elements for residential use

CSM®

APPLICATION DATA:

Operating Limits

· Max. Operating Pressure	125 psi (0.86 MPa)
· Max. Feed Flow Rate	2 gpm (0.45 m ³ /hr)
· Max. Operating Temperature	113 °F (45 °C)
· Operating pH Range	2.0–11.0
· Max. Turbidity	1.0 NTU
· Max. SDI (15 min)	5.0
· Max. Chlorine Concentration	< 0.1 mg/L

The information provided in this document is solely for informative purposes. It is the user's responsibility to ensure the appropriate usage of this product. Woongjin Chemical assumes no obligation, liability or damages incurred for the misuse of the product or for the information provided in this document. This document does not express or implies any warranty as to the merchantability or fitness of the product.

GENERAL HANDLING PROCEDURES

- Elements contained in the boxes must be kept dry at room temperature (7–32°C; 40–95°F) and should not be stored in direct sunlight. If the polyethylene bag is damaged, a new preservative solution (sodium bisulfite) must be added and air-tight sealed to prevent drying and biological growth.
- Permeate from the first hour of operation should be discarded to flush out the preservative solution.
- Elements should be immersed in a preservative solution during storage, shipping and system shutdowns to prevent biological growth and freezing. The standard storage solution contains 1% by weight sodium bisulfite or sodium metabisulfite (food grade). For short term storage (i.e. one week or less) 1% by weight sodium metabisulfite solution is adequate for preventing biological growth.
- Keep elements moist at all times after initial wetting.
- Only use chemicals compatible with the membrane elements and components. Use of such chemicals may void the element limited warranty.
- Permeate pressure must always be equal or less than the feed/concentrate pressure. Damage caused by permeate back pressure voids the element limited warranty.

REF.	MODEL NAME	
	RE2010-LP	
MCRE2012-LP	RE2012-LP	
MCRE2012-LPF	RE2012-LPF	

3" Residential CSM Membranes



RESIDENTIAL

RO elements for residential use

CSM®

SPECIFICATIONS:

General Features

Model Name	Permeate Flow Rate GPD (L/day)	Salt Rejection (%)
RE3012-500	500 (1,893)	97.0

1. The stated product performance is based on data taken after 30 minutes of operation at the following test conditions:

- 200 mg/L NaCl solution at 80 psig (0.55 MPa) applied pressure
- 40% recovery
- 77 °F (25 °C)
- pH 6.5–7.0

2. Minimum salt rejection is 95.0%.

3. Dry type elements are vacuum leak tested using the CSM integrity test.

4. Permeate flows for warranty evaluation may vary +25/-15%.

5. Dry elements are packaged in a polyethylene bag

α Wet elements are packaged in a polyethylene bag containing storage solution.

Membrane type:	Thin-Film Composite
Membrane material:	Polyamide (PA)
Element configuration:	Spiral-Wound, Tape Wrapping

Dimensions

Model Name	A	B	C	D	E
RE3012-500	0.67 (17)	0.39 (10)	11.7 (298)	0.79 (20)	2.95 (75)

*All measurement are in inches(millimeters)



3" Residential CSM Membranes



RESIDENTIAL

RO elements for residential use

CSM®

APPLICATION DATA:

Operating Limits

· Max. Operating Pressure	150 psi (1.03 MPa)
· Max. Feed Flow Rate	2 gpm (0.45 m ³ /hr)
· Max. Operating Temperature	113 °F (45 °C)
· Operating pH Range	2.0–11.0
· Max. Turbidity	1.0 NTU
· Max. SDI (15 min)	5.0
· Max. Chlorine Concentration	< 0.1 mg/L

The information provided in this document is solely for informative purposes. It is the user's responsibility to ensure the appropriate usage of this product. Toray Chemical Korea Inc. assumes no obligation, liability or damages incurred for the misuse of the product or for the information provided in this document. This document does not express or implies any warranty as to the merchantability or fitness of the products.

GENERAL HANDLING PROCEDURES

- Elements contained in the boxes must be kept dry at room temperature (7–32°C; 40–95°F) and should not be stored in direct sunlight. If the polyethylene bag of wet element is damaged, a new preservative solution must be added and air-tight sealed to prevent drying and biological growth.
- When running the system for the first time, the permeate should be discarded continuously at least 1 hour.
- Keep elements moistly at all times after initial wetting.
- Elements should be immersed in a preservative solution during storage, shipping and system shutdowns to prevent biological growth and freezing. The standard storage solution contains 1% by weight sodium bisulfite or sodium metabisulfite (food grade). For short term storage (i.e. one week or less) 1% by weight sodium metabisulfite solution is adequate for preventing from biological growth.
- Only use chemicals compatible with the membrane elements and components. Use of such chemicals may void the element limited warranty.
- Permeate pressure must always be equal or less than the feed/concentrate pressure. Damage caused by permeate back pressure voids the element limited warranty.

REF.	MODEL	
MCRE3012-500	RE3012-500	



RESIDENTIAL

Tankless RO elements for residential use

CSM®

SPECIFICATIONS:

General Features

Model Name	Permeate Flow Rate GPD (L/day)	Salt Rejection (%)
RE3512-TK	600 (2,271)	95.0

1. The stated product performance is based on data taken after 30 minutes of operation at the following test conditions:

- 200 mg/L NaCl solution at 60 psig (0.41 MPa) applied pressure
- 30% recovery
- 77 °F (25 °C)
- pH 6.5–7.0

2. Minimum salt rejection is 93.0%.

3. Dry type elements are vacuum leak tested using the CSM integrity test.

4. Permeate flow rate for each element may vary but will be no more than 15%.

5. Dry elements are packaged in a polyethylene bag.

Membrane type:	Thin-Film Composite
Membrane material:	Polyamide (PA)
Element configuration:	Spiral-Wound, Tape Wrapping

Dimensions

Model Name	A	B	C	D	E
RE3512-TK	0.67 (17)	0.31 (8)	11.73 (298)	0.63 (16)	3.35 (85)

*All measurements are in inches (millimeters).





RESIDENTIAL

Tankless RO elements for residential use

CSM[®]

APPLICATION DATA:

Operating Limits

· Max. Operating Pressure	150 psi (1.03 MPa)
· Max. Feed Flow Rate	5 gpm (1.14 m ³ /hr)
· Max. Operating Temperature	113 °F (45 °C)
· Operating pH Range	2.0–11.0
· Max. Turbidity	1.0 NTU
· Max. SDI (15 min)	5.0
· Max. Chlorine Concentration	< 0.1 mg/L

The information provided in this document is solely for informative purposes. It is the user's responsibility to ensure the appropriate usage of this product. Toray Chemical Korea Inc. assumes no obligation, liability or damages incurred for the misuse of the product or for the information provided in this document. This document does not express or imply any warranty as to the merchantability or fitness of the product.

GENERAL HANDLING PROCEDURES

- Elements contained in the boxes must be kept dry at room temperature (7–32°C; 40–95°F) and should not be stored in direct sunlight.
- When running the system for the first time, the permeate should be discarded continuously at least 1 hour.
- Keep elements moistly at all times after initial wetting.
- Elements should be immersed in a preservative solution during storage, shipping and system shutdowns to prevent biological growth and freezing. The standard storage solution contains 1% by weight sodium bisulfite or sodium metabisulfite (food grade). For short term storage (i.e. one week or less) 1% by weight sodium metabisulfite solution is adequate for preventing from biological growth.
- Only use chemicals compatible with the membrane elements and components. Use of such chemicals may void the element limited warranty. For additional information on use of approved chemicals please contact your nearest CSM representative.
- Permeate pressure must always be equal or less than the feed/concentrate pressure. Damage caused by permeate back pressure voids the element limited warranty.

REF.	MODEL NAME	
MCRE3512-TK	RE3512-TK	

1,8" - 2" Residential CSM Membranes



RESIDENTIAL

NF elements for residential use

CSM®

SPECIFICATIONS:

General Features

Model Name	Permeate Flow Rate GPD (L/day)	Salt Rejection %
NE1812	80 (379)	40.0–60.0%
NE2010	90 (341)	40.0–60.0%

- The stated product performance is based on data taken after 30 minutes of operation at the following test conditions:
 - 250 mg/L NaCl solution at 60 psig (4.14 MPa) applied pressure
 - 15% recovery
 - 77 °F (25 °C)
 - pH 6.5–7.0
- Dry type elements are vacuum leak tested using the San Diego Protocol.
- Permeate flow rate for each element may vary but will be no more than 15%.
- All elements are packaged in a polyethylene bag containing 1.0% SBS (sodium bisulfite) solution.

Membrane type: Thin-Film Composite
Membrane material: Polyamide (PA)
Element configuration: Spiral-Wound, Tape Wrapping

Dimensions

Model Name	A	B	C	D	E
NE1812	0.67	0.87	11.73	0.87	1.77
NE2010	0.67	0.63	10.08	0.87	1.91

*All measurement are in inches

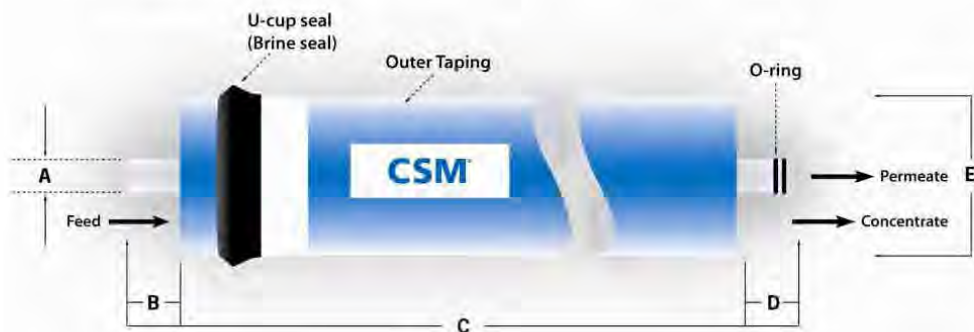

1,8" - 2" Residential CSM Membranes



RESIDENTIAL

NF elements for residential use

CSM[®]

APPLICATION DATA:

Operating Limits

· Max. Operating Pressure	125 psi (0.86 MPa)
· Max. Feed Flow Rate	2 gpm (0.45 m ³ /hr)
· Max. Operating Temperature	113 °F (45 °C)
· Operating pH Range	2.0–11.0
· Max. Turbidity	1.0 NTU
· Max. SDI (15 min)	5.0
· Max. Chlorine Concentration	< 0.1 mg/L

The information provided in this document is solely for informative purposes. It is the user's responsibility to ensure the appropriate usage of this product. Woongjin Chemical assumes no obligation, liability or damages incurred for the misuse of the product or for the information provided in this document. This document does not express or implies any warranty as to the merchantability or fitness of the product.

GENERAL HANDLING PROCEDURES

- Elements contained in the boxes must be kept dry at room temperature (7–32°C; 40–95°F) and should not be stored in direct sunlight. If the polyethylene bag is damaged, a new preservative solution (sodium bisulfite) must be added and air-tight sealed to prevent drying and biological growth.
- Permeate from the first hour of operation should be discarded to flush out the preservative solution.
- Elements should be immersed in a preservative solution during storage, shipping and system shutdowns to prevent biological growth and freezing. The standard storage solution contains 1% by weight sodium bisulfite or sodium metabisulfite (food grade). For short term storage (i.e. one week or less) 1% by weight sodium metabisulfite solution is adequate for preventing biological growth.
- Keep elements moist at all times after initial wetting.
- Only use chemicals compatible with the membrane elements and components. Use of such chemicals may void the element limited warranty.
- Permeate pressure must always be equal or less than the feed/concentrate pressure. Damage caused by permeate back pressure voids the element limited warranty.

REF.	MODEL NAME	
MCNE1812	NE1812	
	NE2010	

1,8" - 2" Residential CSM Membranes



RESIDENTIAL

UF elements for residential use

CSM[®]

SPECIFICATIONS:

General Features

Model Name	Permeate Flow Rate GPD (L/day)	Molecular Weight Cut Off
UE1810	200 (757)	100K
UE1812	250 (946)	100K
UE2010	450 (1,703)	100K

1. The stated product performance is based on data taken after 30 minutes of operation at the following test conditions:

- Pure water (2 MΩ) at 20 psig applied pressure
- 100% recovery
- 77 °F (25 °C)

2. Dry type elements are vacuum leak tested using the San Diego Protocol.

3. Permeate flow rate for each element may vary but will be no more than 15%.

4. Dry elements are packaged in a polyethylene bag

- α Wet elements are packaged in a polyethylene bag containing SB(4g/L) + HCl(0.51g/L) solution.

Membrane type: Thin-Film Composite

Membrane material: Polysulfone (PSF)

Element configuration: Spiral-Wound, Tape Wrapping

Dimensions

Model Name	A	B	C	D	E
UE1810	0.67	0.55	10.08	0.98	1.77
UE1812	0.67	0.55	11.02	0.79	1.77
UE2010	0.67	0.55	10.08	0.98	1.91

*All measurement are in inches

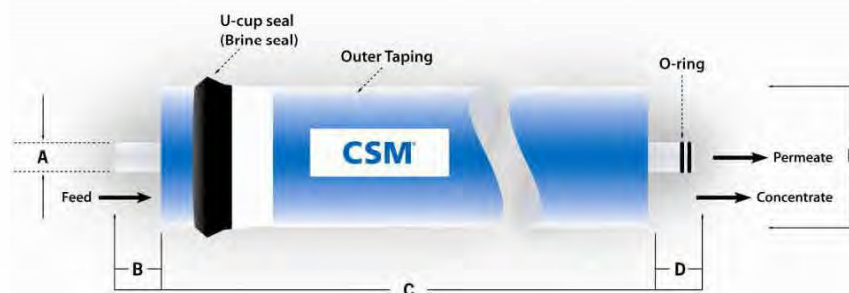

These model names are tested and certified under NSF/ANSI standard 58, material requirement only (excluding UE1812)

1,8" - 2" Residential CSM Membranes



RESIDENTIAL

UF elements for residential use

CSM[®]

APPLICATION DATA:

Operating Limits

· Max. Operating Pressure	125 psi (0.86 MPa)
· Max. Feed Flow Rate	2 gpm (0.45 m ³ /hr)
· Max. Operating Temperature	113 °F (45 °C)
· Operating pH Range	2.0–11.0
· Max. Turbidity	1.0 NTU
· Max. SDI (15 min)	5.0

The information provided in this document is solely for informative purposes. It is the user's responsibility to ensure the appropriate usage of this product. Woongjin Chemical assumes no obligation, liability or damages incurred for the misuse of the product or for the information provided in this document. This document does not express or implies any warranty as to the merchantability or fitness of the product.

GENERAL HANDLING PROCEDURES

- Elements contained in the boxes must be kept dry at room temperature (7–32°C; 40–95°F) and should not be stored in direct sunlight. If the polyethylene bag is damaged, a new preservative solution (sodium bisulfite) must be added and air-tight sealed to prevent drying and biological growth.
- Permeate from the first hour of operation should be discarded to flush out the preservative solution.
- Elements should be immersed in a preservative solution during storage, shipping and system shutdowns to prevent biological growth and freezing. The standard storage solution contains 1% by weight sodium bisulfite or sodium metabisulfite (food grade). For short term storage (i.e. one week or less) 1% by weight sodium metabisulfite solution is adequate for preventing biological growth.
- Keep elements moist at all times after initial wetting.
- Only use chemicals compatible with the membrane elements and components. Use of such chemicals may void the element limited warranty.
- Permeate pressure must always be equal or less than the feed/concentrate pressure. Damage caused by permeate back pressure voids the element limited warranty.

REF.	MODEL NAME	
	UE1810	
MCUE1812 (*)	UE1812	
	UE2010	

(*) available till it will be out-of-stock.

Vessel for Residential Elements



1,8" - 2" membranes

- material PP white;
- connections 1/8" NPT F;
- max pressure 125 psi (8,6 bar);
- double o-ring;
- permeate tube seat diameter = 0,67";
- nominal dimension 1812 - 2012.



REF.	
DE010	

Membranes coupling:

- CSM 1,8" - 2" residential membranes, see 10-01-01-EN, 10-01-02-EN, 10-01-03-EN, 10-01-04-EN, 10-01-07-EN and 10-01-08-EN data sheets.

Single mounting clips for vessel residential 1,8" - 2" membranes

- material PP;
- white colour.

REF.	
DE034	



2,8" - 3" membranes

- material PP white;
- connections:
 - feed, permeate and concentrate 3/8" NPT F (please, use our fittings ref. AV153 or elbows ref. AV159);
- max pressure 125 psi (8,6 bar);
- permeate tube seat diameter = 0,67";
- nominal dimension 2812 - 3012.



REF.	
DE007	

Membranes coupling:

- CSM 2,8" residential membranes, see 10-01-02-EN and 10-01-05-EN data sheets.

Single mounting clips for vessel residential 2,8" - 3" membranes

- material PP;
- white colour.

REF.	
DE006	



In-Line Cartridges



- IN LINE cartridges ¼" NPT F connections;
- Max pressure = 100 psi (7 bar);
- Max temperature = 35°C;
- D.M. n.174 dated 06/04/2004 compliant about materials suitable for contact with water for human consumption.

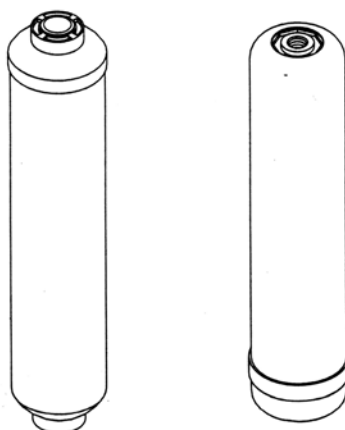

REF.	DIAMETER (inch)	LENGTH (inch)	VERSION	FLOW (gpm)	
DE028	2"	10"	Coconut Shell Activated Carbon	0,75	
DE029	2"	10"	Sediment	0,75	
DE030	2 ½"	11"	Coconut Shell Activated Carbon	1,00	
DE031	2 ½"	11"	Sediment	1,00	

R.O. compact assembly and accessories

REF.	DESCRIPTION	
DE100	Compact assembly empty	
DE101	Special membrane 50 GPD	
DE102A	Sediment / Carbon Block Prefilter cartridge	
DE103	GAC Postfilter cartridge	

Permeate Pump for Residential R.O. Systems



- using the energy of the brine water of the R.O. system to pump the permeate into the pressure tank, increases the net operating pressure on the membrane and eliminate the negative effect of the pressure on the storage tank;
- hydraulic pump, does not require electricity;
- for residential R.O. systems with pressurized storage tank and membrane from 35 to 100 GPD;
- the permeate pump can increase up to 5 time the system recovery, reducing the water consumption and the refill time of the storage tank;
- no shut-off valve is needed;
- materials polypropylene/ EPDM;
- max operating pressure 6,8 bar;
- connections for 1/4" tubing;
- max drain flow rate 0,8 l/min.

REF.	
DE120	

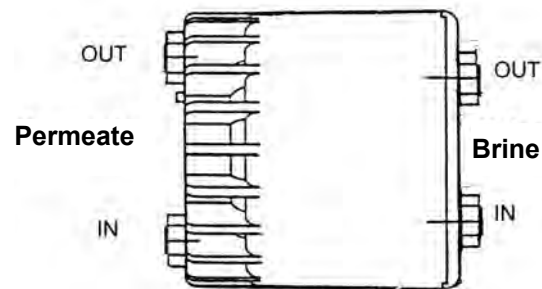

Typical system layout

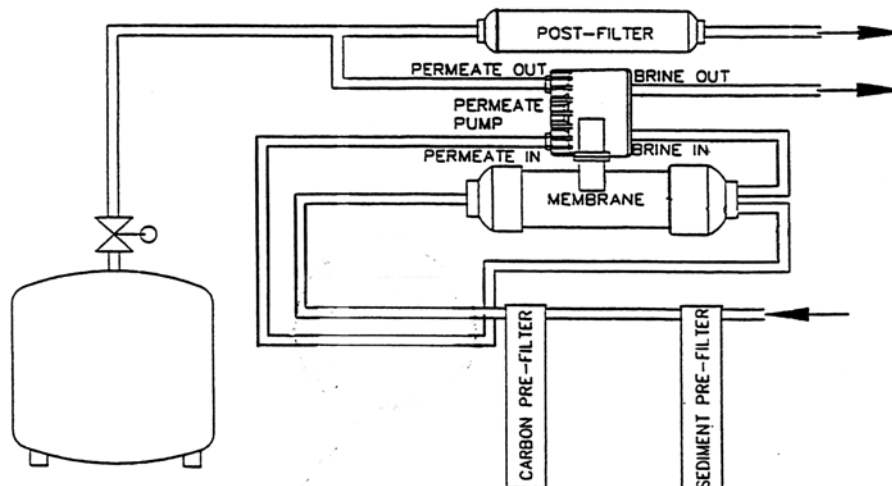

ATTENTION

Install the pump horizontal with both outlet ports in the highest position so that any air purges out automatically.

The concentrate flow restrictor has to be installed before the permeate pump inlet.

ACCESSORIE		
REF.	DESCRIPTION	
DE121	SINGLE MOUNTING CLIP	

Booster Pump for Residential R.O.



- booster pump and relevant accessories for residential R.O. Systems.
- membrane booster pump with transformer;
- transformer power supply 220 V – 50 Hz;
- IN/OUT connections 3/8" F.

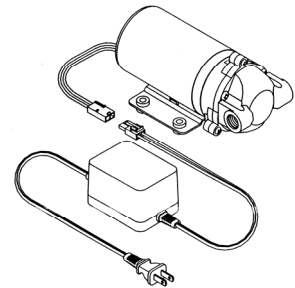

REF.	MODEL	POWER SUPPLY	FLOW (liters/min)		
			60 psi	100 psi	
DE130	E36	24 VAC	0,8	0,6	

Accessories:

High/low pressure switch

- pressure 30 – 50 psi;
- connections 1/4" tube.

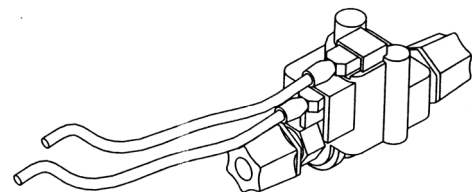

REF.	
DE140	

- to use as high pressure switch contacts C and NC;
- to use as low pressure switch contacts C and NO.

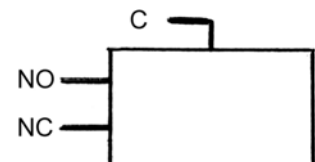

Typical system layout

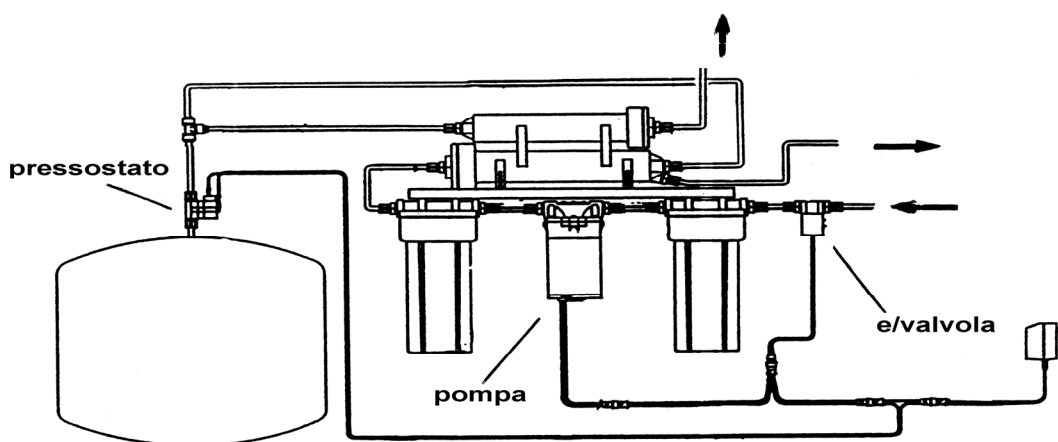

MWG Booster Pumps for Residential R.O.



- MWG booster pumps for residential R.O. Systems;
- Membrane booster pumps without transformer (to order separately);
- IN/OUT connections 3/8" F;
- Conform with CE safety Directives;
- D.M. n.174 dated 06/04/2004 compliant about materials suitable for contact with water for human consumption.



REF.	MODEL	POWER SUPPLY	TRANSFORMER REF.	INLET PRESSURE (psi)	WORKING PRESSURE RANGE (psi)	FLOW @ 70 psi (l/min)	RATED CURRENT (A)	CURRENT @ 70 psi (A)
DH501	M100G	24 VDC	DH531	30	60 ÷ 80	≥ 1,1	1,8	≤ 1,2
DH503	L200G	24 VDC	DH533	30	60 ÷ 80	≥ 1,6	2,2	≤ 1,6
DH505	L400G	24 VDC	DH535	30	70 ÷ 90	≥ 2,6	3,6	≤ 2,5

TRANSFORMERS

REF.	MODEL
DH531	24VDC 2,0A
DH533	24VDC 2,5A
DH535	24VDC 4,0A

DH501

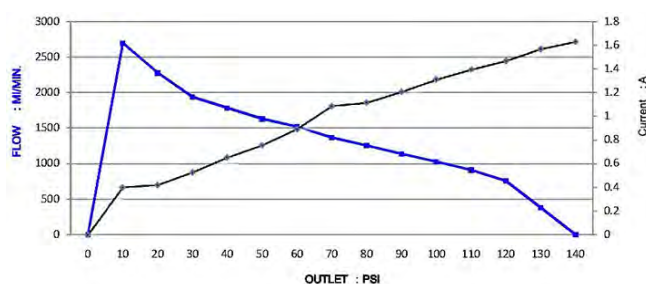

DH503

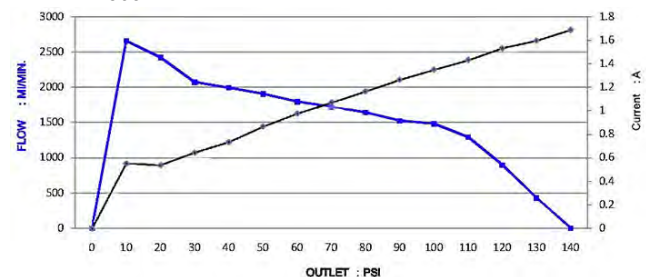

DH505

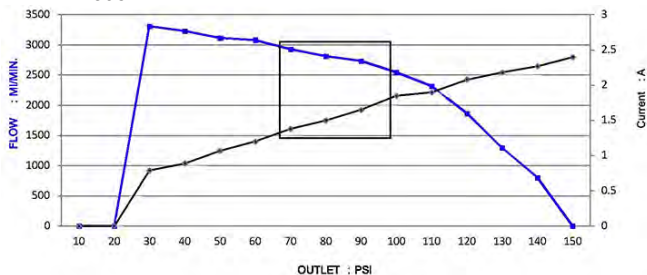

Two-Way Solenoid Valves for R.O. Systems



- two-way solenoid valve direct acting;
- body material plastic;
- connections 1/4" NPT;
- power supply 24 VAC;
- orifice diameter 2,5 mm.



REF.	
DE142	

- two-way solenoid valve direct acting;
- body material brass.



Ref. DE144



Ref. DE147

REF.	CONNECTIONS (inch)	POWER SUPPLY	ORIFICE DIAMETER (mm)	
DE144	1/4"	24 VDC	3,0	
DE147	3/8"	220 VAC	4,5	

Valves for Residential R.O. and Filtration System



Saddle Valve

- saddle valve self piercing for residential R.O and filtration systems;
- suitable for copper piping;
- connection for 1/4" tubing;
- material brass with aluminium clamp.

REF.	
DE041	



Needle Valves

- needle valve for residential R.O and filtration systems;
- for tube 1/2" M/F or 3/8" M/F;
- connection for 1/4" or 3/8" or 5/16" flexible tubing;
- material brass.



REF.	TUBE (inch)	FLEXIBLE TUBING (inch)	
DE039	1/2" M/F	1/4"	
DE050	1/2" M/F	3/8"	
DE050A	1/2" M/F	5/16"	
DE039A	3/8" M/F	1/4"	

Drain and Diverter Valves for R.O. Systems



- suitable for residential R.O and filtration systems.

Drain Clamp

- material ABS black.

REF.	CONNECTION (inch)	
DE040	¼" tubo	
DE049	¼" F NPT	



Diverter Valve with Swivel Collar

- connection for ¼" tubing;
- material chrome plated brass.

REF.	
DE042	



ADAPTER 15/16" – 27 X 55/64" – 27

- length 8 mm;
- material chrome plated brass.

REF.	
DE043	



Jaco Style Fittings



- Range of polypropylene fittings, white colour, for residential R.O. and filtration systems.

STRAIGHT			
REF.	THREADED CONNECTION (inch)	FOR TUBE (inch)	
DE063	1/8"	1/4"	
DE064	1/4"	1/4"	
DE068	1/4" F	1/4"	
DE069	3/8"	1/4"	

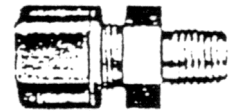

ELBOWS			
REF.	THREADED CONNECTION (inch)	FOR TUBE (inch)	
DE060	1/8"	1/4"	
DE062	1/8" F	1/4"	
DE061	1/4"	1/4"	
DE070	3/8"	1/4"	

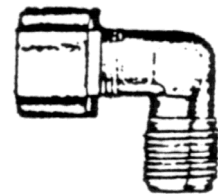

TEES				
REF.	1/4" THREAD POSITION	THREADED CONNECTION (inch)	FOR TUBE (inch)	
DE065	LATERAL	1/4"	1/4"	
DE066	CENTRAL	1/4"	1/4"	
DE067	-	-	1/4"	

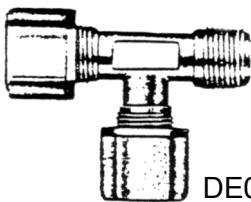

DE065

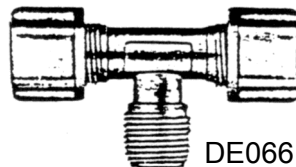

DE066

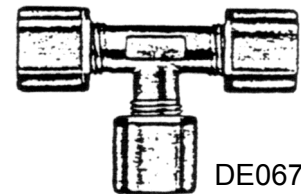

DE067

BULKHEAD UNION		
REF.	FOR TUBE (inch)	
DE085 (*)	1/4"	



(*) available till it will be out-of-stock.



In-Line Flow Restrictors

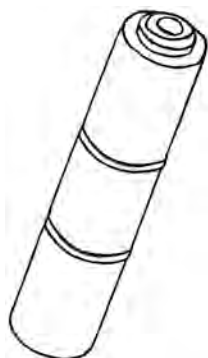

- Quick connections 1/4" tube.

REF.	Flow @ 60 psi (gpd)	Flow @ 60 psi (ml/min)	
DE105	60	150	
DE106	115	300	
DE107	150	400	
DE108	208	550	
DE109	227	600	
DE110	300	800	

JACO Style Check Valve

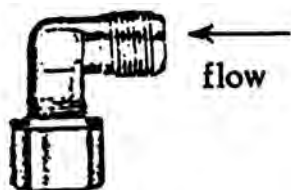

- Jaco style elbow 1/8" x 1/4" tube complete with AISI check-valve.

REF.	
DE079	

S.S. Check Valve

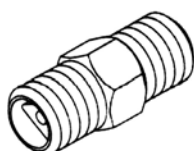

- Stainless steel check valve 1/8" x 1/8".

REF.	
DE048	



PP Storage Tanks

- pressurized storage tank for treated water;
- white colour;
- connection 1/4" NPT;
- min. operating pressure 1 bar.



REF.	CAPACITY (liters)	MATERIAL	DIAMETER (mm)	HEIGHT (mm)	MAX PRESSURE (bar)	
DE032	12	PP / acciaio	240	370	7,0	
DE051	15	PP	260	400	3,5	

Steel Storage Tanks

- pressurized storage tank for R.O water;
- material painted steel, white colour;
- connection 1" BSPP female;
- with threaded extension M 1" x 1/4", with elbowed ball valve with connection 3/8" tubing;
- min. operating pressure 1 bar;
- max operating pressure 7 bar.



REF.	CAPACITY (liters)	DIAMETER (mm)	HEIGHT (mm)	
DE096	41	390	575	
DE097	75	390	770	



Elbowed Ball Valve

- material white plastic;
- connections 1/4" F NPT x 1/4" tubing.

REF.	
DE052	



Automatic Shut-Off Valve

- material white ABS;
- connections 1/4" tubing;
- max pressure 125 psi (8,5 bar).

REF.	
DE038	



Mechanical Flow Meter

- adjustable setting;
- automatic shut-off based on volume;
- capacity 7000 litres;
- connections 1/4" NPT;
- operating pressure 1 ÷ 8,5 bar;
- material ABS, black colour.

REF.	
DE080	





Single Mounting Clips

- PP material;
- white colour.

REF.	DIAMETER (inch)	DIAMETER (mm)	
DE033	2"	50	
DE034	2 1/2"	60	
DE006	3"	90	



Double Mounting Clips

- PP material;
- white colour.

REF.	DIAMETER (inch)	DIAMETER (mm)	
DE035	2" x 2 1/2"	50 x 60	
DE036	2 1/2" x 2 1/2"	60 x 60	



Flexible 1/4" Tubing

- hanks of 50 m (100 m only for DE081).

REF.	DIAMETER (inch)	DIAMETER (mm)	
DE082	PVC	White	
DE083	PE	Blue	
DE084	PE	Black	
DE086	PE	Red	
DE081	PE	Clear	



Needle Valve In-Line Style

- brass material.

(*) available till it will be out-of-stock.

REF.	TUBE CONNECTIONS	
DE098 (*)	1/4"	
DE098A (*)	3/8"	



Insert for Flexible 1/4" Tubing

- CELCON material.

REF.	
DE059	





Long Reach Faucet

- material chrome plated;
- connection for ¼" tubing;
- complete with installation kit;
- threaded tube length 50 mm.

REF.	
DE037	

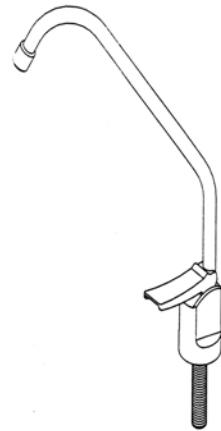

Quarter-Turn faucet

- metal and plastic chrome material;
- connection for ¼" tubing;
- complete with installation kit;
- threaded tube length 71 mm;
- wetted materials suitable for drinking water use;
- conform to the requirements of NSF/ANSI 61.

REF.	
DE116	



Single Handle Faucet with Drinking Nozzle

- monobloc, material chrome plated;
- adjustable necks;
- hot and cold water connections ½" with needle valves;
- treated water connection ¼" tube;
- complete with installation kit.

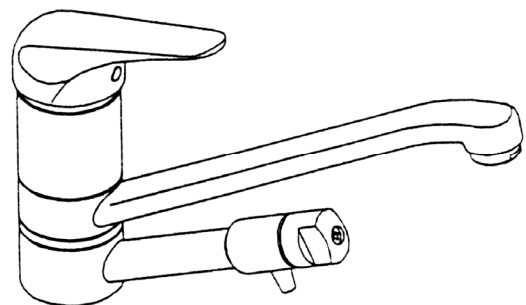

REF.	
DE087	



Pressure Gauge

- pressure set 0 ÷ 10 bar;
- connection 1/8" M;
- diameter 25 mm.

REF.	
DE077	



3 Ways Adapter for Pressure Gauge

- plastic material;
- connections 1/8" F x 1/8" M x 1/4" tube.

REF.	
DE078	



Check Valve in Line

- plastic material;
- 1/4" tube quick connections.

REF.	
DE089	



MD, DD and TD two Pieces Filter Housings IN/OUT connections 1/4" for R.O. Systems



REF.
FBMD1002T



REF.
FBMD1002W



REF.
FBDD1002W



REF.
FBTD1002W

- Made in European Union (Italy);
- Suitable for residential R.O. and filtration systems;
- Two pieces filter housings for standard filtering cartridges length 10"
- Total height 325 mm;
- Fixable head (single, double or triplex) in material PP reinforced white colour;
- Sump in PET clear or white, O-ring in EPDM;
- IN/OUT connections 1/4" BSPP F;
- With air valve;
- Max operating pressure 8 bar, temperature 4 ÷ 45°C;
- D.M. n.174/2004 compliant about materials suitable for contact with water for human consumption;
- D.M. n.25/2012 compliant about technical provisions for equipment intended for water treatment for human consumption;
- In compliance with the sanitary certification ACS (France).
- Designed for the following single, double or triple brackets (also ideal for 2 + 1 application), with fixing screws.

REF.	MODEL	CARTRIDGE LENGTH (inch)	SUMP MATERIAL AND COLOUR	HEAD DIMENSION (mm)	TOTAL LENGTH (mm)
FBMD1002T	MD1002T	Single	Clear	122	12,35
FBMD1002W	MD1002W	Single	White	122	12,35
FBDD1002W	DD1002W	Duplex	White	228	26,34
FBTD1002W	TD1002W	Triplex	White	336	36,96

Accessories

REF.	DESCRIPTION
FBMDR11	PLASTIC WRENCH FOR MD FILTER HOUSINGS
FBMDR22	WHITE BRACKET WITH SCREWS FOR MD AND MT FILTER HOUSINGS
FBMDR24	WHITE BRACKET WITH SCREWS FOR DD AND DT TWO FILTER HOUSINGS
FBMDR26	WHITE BRACKET WITH SCREWS FOR TD AND TT THREE FILTER HOUSINGS

Flow Restrictor Linear Type



- capillary adjusting flow system with insertion in tube 1/4" diameter ($\varnothing e=6,35$ mm);
- 200 mm standard length; you can change the length as required (please see the diagram below);
- PP material insert: PE material capillary tube;
- range of operating pressure 2 ÷ 8 bar.

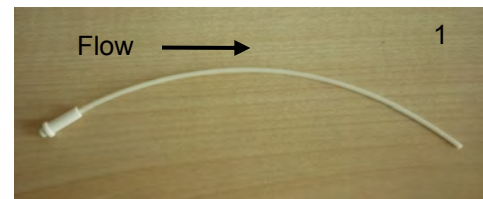

ITEM	DESCRIPTION	REF.
1	FLOW RESTRICTOR LINEAR TYPE; L = 200 MM	DE122
2	FLOW RESTRICTOR FRT-14P INSERT	DE124
3	CAPILLARY TUBE (25 M ROLL)	DE125
4	FLOW RESTRICTOR JACO DOUBLE INSERT OPEN	DE123

WARNING: it is essential that the cutting of the capillary be net and tube perfectly circular (you can use an awl in order to restore the circular form), otherwise the flow rate value can be greatly altered. Observe the flow direction as shown in Picture n.1.

Flow restrictor linear type

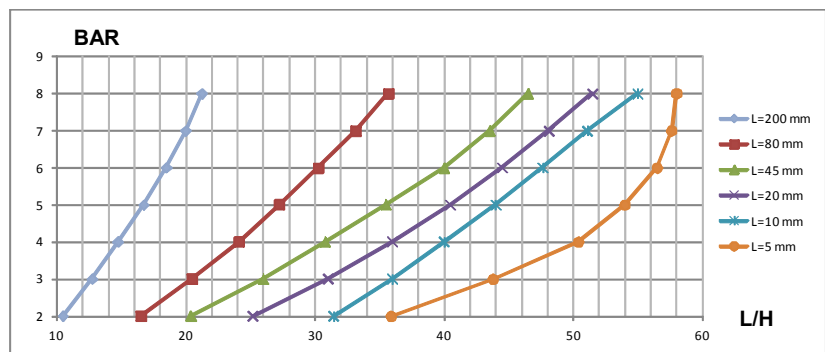

Flow restrictor Jaco 1/4" double insert open

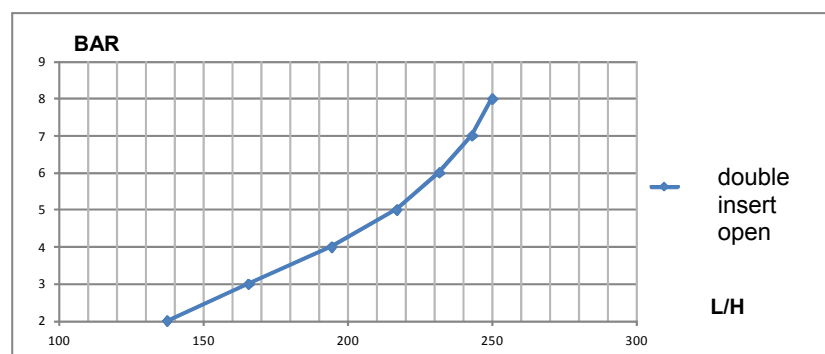



- Suitable for residential R.O. and filtration systems;
- Designed for water, food and air contact but can be used with selected gases, vacuum & other liquids;
- DM 174 (Italy) dated 06/04/2004 compliant about materials suitable for contact with water for human consumption;
- In compliance with the sanitary certification ACS (France);
- In acetal resin grey color, non-toxic and NSF approved material;
- Pressure max 16 bar @ 25°C.

MALE CONNECTOR NPTF

REF.	T NPT THREADED CONNECTION (inch)	Ø D CONNECTION (inch)	A (mm)	B (mm)	Ø E (mm)	H (mm)	L (mm)
DH005	1/8"	1/4"	9,1	16,9	17,8	15,8	27,0
DH006	1/4"	1/4"	13,2	16,9	17,8	15,8	27,0
DH007	3/8"	1/4"	13,8	16,9	21,4	19,0	26,1
DH012	1/8"	3/8"	9,1	20,2	23,0	20,6	30,4
DH013	1/4"	3/8"	13,2	20,2	23,0	20,6	34,3
DH014	3/8"	3/8"	13,8	20,2	23,0	20,6	29,9

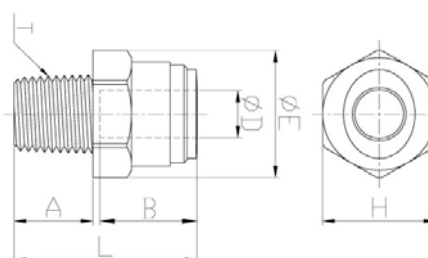

FEMALE ADAPTER NPTF

REF.	T NPT THREADED CONNECTION (inch)	Ø D CONNECTION (inch)	Ø P (mm)	A (mm)	B (mm)	Ø E (mm)	H (mm)	L (mm)
DH021	1/8"	1/4"	15,5	11,5	16,9	19,0	17	30,9
DH022	1/4"	1/4"	15,5	11,5	16,9	21,5	19	30,9
DH023	1/4"	3/8"	20,0	11,5	20,2	21,5	19	34,2

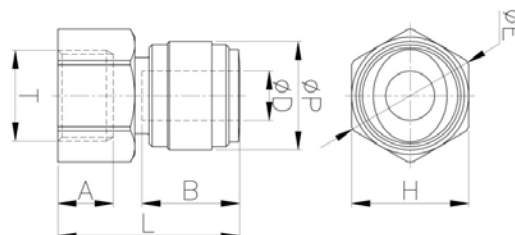



- Suitable for residential R.O. and filtration systems;
- Designed for water, food and air contact but can be used with selected gases, vacuum & other liquids;
- DM 174 (Italy) dated 06/04/2004 compliant about materials suitable for contact with water for human consumption;
- In compliance with the sanitary certification ACS (France);
- In acetal resin grey color, non-toxic and NSF approved material;
- Pressure max 16 bar @ 25°C.

MALE ELBOW NPT

REF.	T NPT THREADED CONNECTION (inch)	Ø D CONNECTION (inch)	Ø P (mm)	A (mm)	B (mm)	E (mm)	H (mm)	L (mm)
DH033	1/8"	1/4"	15,5	9,1	16,9	26,4	11,0	25,6
DH034	1/4"	1/4"	15,5	13,2	16,9	31,9	11,0	27,0
DH035	3/8"	1/4"	15,5	13,8	16,9	32,7	11,0	28,9
DH038	1/4"	3/8"	20,0	13,2	20,2	35,2	14,3	31,8
DH039	3/8"	3/8"	20,0	13,8	20,2	35,8	14,3	33,9

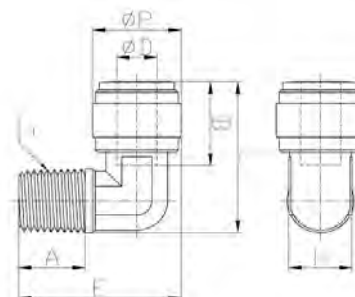

BULKHEAD CONNECTOR

REF.	T	Ø D ₁ CONNECTION (inch)	Ø D ₂ CONNECTION (inch)	B ₁ (mm)	B ₂ (mm)	H ₁ (fixed)	H ₂ (mm)	L (mm)
DH052	M17	1/4"	1/4"	16,9	16,9	19	21	35,7
DH054	M24	3/8"	3/8"	20,2	20,2	24	25,5	42,4

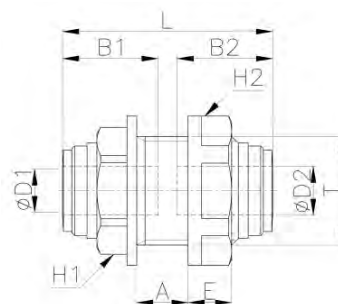



- Suitable for residential R.O. and filtration systems;
- Designed for water, food and air contact but can be used with selected gases, vacuum & other liquids;
- DM 174 (Italy) dated 06/04/2004 compliant about materials suitable for contact with water for human consumption;
- In compliance with the sanitary certification ACS (France);
- In acetal resin grey color, non-toxic and NSF approved material;
- Pressure max 16 bar @ 25°C.

UNION ELBOW TUBE WITH STEM

REF.	Ø D ₁ CONNECTION (inch)	Ø D ₂ CONNECTION (inch)	Ø P (mm)	A (mm)	B (mm)	E (mm)	L (mm)
DH063	1/4"	1/4"	15,5	21,0	16,9	34,8	25,1
DH065	3/8"	3/8"	20,0	24,8	20,2	43,2	31,4
DH067	3/8"	1/4"	17,6	22,5	17,5	38,3	27,7

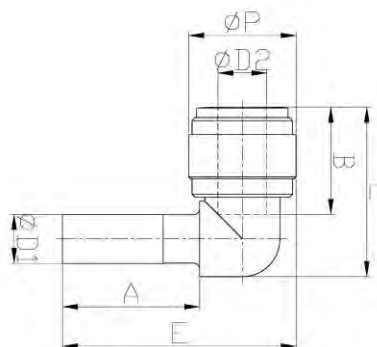

UNION CONNECTOR

REF.	Ø D ₁ CONNECTION (inch)	Ø D ₂ CONNECTION (inch)	B ₁ (mm)	B ₂ (mm)	Ø E (mm)	L (mm)
DH073	1/4"	1/4"	16,9	16,9	15,5	36,2
DH075	3/8"	3/8"	20,2	20,2	20,0	42,9
DH079	3/8"	1/4"	20,2	16,9	20,0	42,1

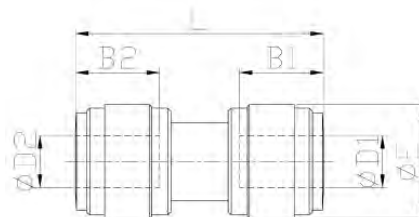



- Suitable for residential R.O. and filtration systems;
- Designed for water, food and air contact but can be used with selected gases, vacuum & other liquids;
- DM 174 (Italy) dated 06/04/2004 compliant about materials suitable for contact with water for human consumption;
- In compliance with the sanitary certification ACS (France);
- In acetal resin grey color, non-toxic and NSF approved material;
- Pressure max 16 bar @ 25°C.

UNION ELBOW

REF.	Ø D ₁ CONNECTION (inch)	Ø D ₂ CONNECTION (inch)	B ₁ (mm)	B ₂ (mm)	Ø E ₁ (mm)	Ø E ₂ (mm)	L (mm)	H (mm)	
DH083	1/4"	1/4"	16,9	16,9	15,5	15,5	28,8	28,8	
DH085	3/8"	3/8"	20,2	20,2	20,0	20,0	35,9	35,9	

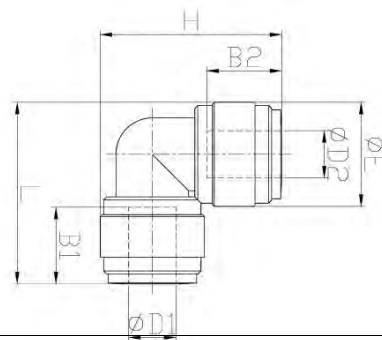

UNION T

REF.	Ø D ₁ CONNECTION (inch)	Ø D ₂ CONNECTION (inch)	Ø D ₃ CONNECTION (inch)	B ₁ (mm)	B ₂ (mm)	B ₃ (mm)	Ø E (mm)	L (mm)	H (mm)	
DH093	1/4"	1/4"	1/4"	16,9	16,9	16,9	15,5	42,0	28,8	
DH095	3/8"	3/8"	3/8"	20,2	20,2	20,2	20,0	51,8	35,9	

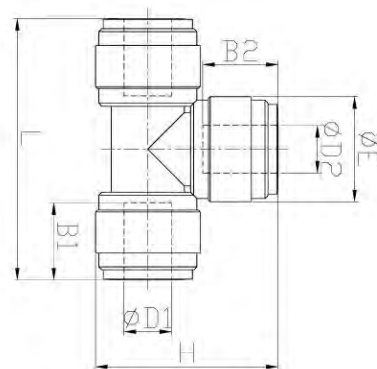



- Suitable for residential R.O. and filtration systems;
- Designed for water, food and air contact but can be used with selected gases, vacuum & other liquids;
- DM 174 (Italy) dated 06/04/2004 compliant about materials suitable for contact with water for human consumption;
- In compliance with the sanitary certification ACS (France);
- In acetal resin grey color, non-toxic and NSF approved material;
- Pressure max 16 bar @ 25°C.

TWO WAY DIVIDER

REF.	Ø D ₁ CONNECTION (inch)	Ø D ₂ CONNECTION (inch)	B ₁ (mm)	B ₂ (mm)	Ø P ₁ (mm)	Ø P ₂ (mm)	L (mm)	J (mm)	C (mm)
DH103	1/4"	1/4"	16,9	16,9	15,5	15,5	38,8	15,5	3,3
DH105	3/8"	3/8"	20,2	20,2	20,0	20,0	46,4	20,0	4,5

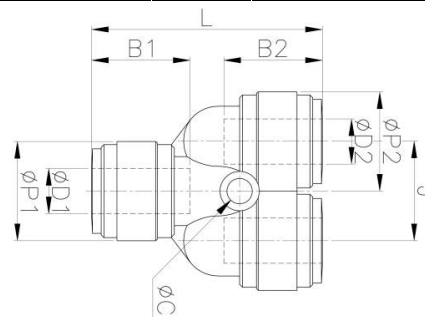

MALE SWIVEL TEE NPTF

REF.	T NPT THREADED CONNECTION (inch)	Ø D CONNECTION (inch)	Ø P (mm)	A (mm)	B (mm)	E (mm)	H (mm)	L (mm)
DH112	1/4"	1/4"	15,5	13,2	16,9	21,0	17,46	36,9
DH114	3/8"	3/8"	20,0	13,0	20,2	25,9	21,4	41,8

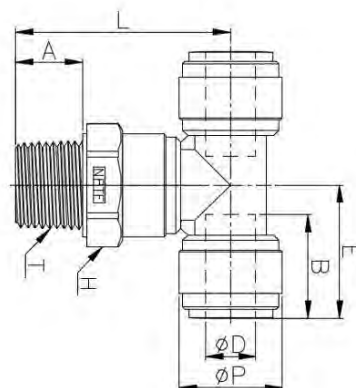



- Suitable for residential R.O. and filtration systems;
- Designed for water, food and air contact but can be used with selected gases, vacuum & other liquids;
- DM 174 (Italy) dated 06/04/2004 compliant about materials suitable for contact with water for human consumption;
- In compliance with the sanitary certification ACS (France);
- In acetal resin grey color, non-toxic and NSF approved material;
- Pressure max 16 bar @ 25°C.

MALE SWIVEL RUN TEE NPTF

REF.	T NPT THREADED CONNECTION (inch)	Ø D CONNECTION (inch)	Ø P (mm)	A (mm)	B (mm)	E (mm)	H (mm)	L ₁ (mm)	L ₂ (mm)
DH122	1/4"	1/4"	15,5	13,2	16,9	21,0	17,46	36,9	57,9
DH124	3/8"	3/8"	20,0	13,0	20,2	25,9	21,4	41,8	67,7

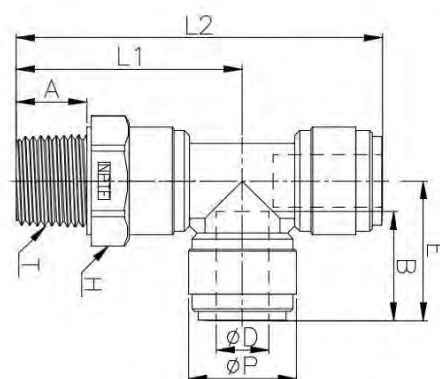

CHECK VALVES

REF.	Ø D CONNECTION (inch)	Ø P (mm)	B (mm)	L (mm)
DH131	1/4"	15,5	16,1	45,5
DH133	3/8"	20,0	19,5	57,8

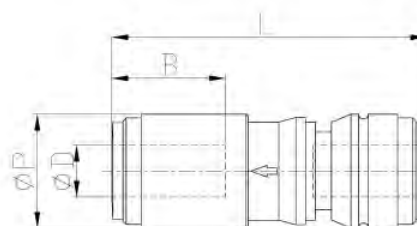



- Suitable for residential R.O. and filtration systems;
- Designed for water, food and air contact but can be used with selected gases, vacuum & other liquids;
- DM 174 (Italy) dated 06/04/2004 compliant about materials suitable for contact with water for human consumption;
- In compliance with the sanitary certification ACS (France);
- In acetal resin grey color, non-toxic and NSF approved material;
- Pressure max 16 bar @ 25°C.

2 WAYS HAND VALVES

REF.	Ø D ₁ CONNECTION (inch)	Ø D ₂ CONNECTION (inch)	B ₁ (mm)	B ₂ (mm)	Ø P ₁ (mm)	Ø P ₂ (mm)	L ₁ (mm)	L ₂ (mm)	E (mm)	Ø C (mm)
DH141	1/4"	1/4"	16,1	16,1	15,5	15,5	9,5	34,5	51,7	19,2
DH143	3/8"	3/8"	20,2	20,2	20,0	20,0	12,5	42,3	63,2	24,2

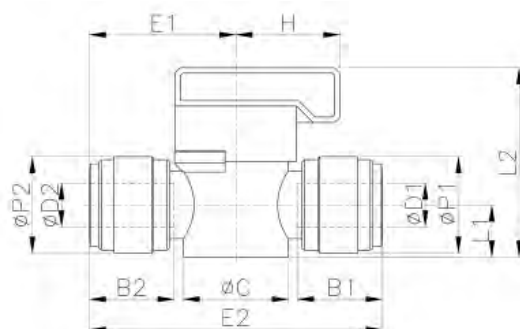

BULKHEAD FLOW REGULATORS

REF.	Ø D CONNECTION (inch)	T	Ø P (mm)	A (mm)	B (mm)	E ₁ (mm)	E ₂ (mm)	H (mm)	L min (mm)	L max (mm)
DH157	1/4"	M12	15,5	5,0	16,9	22,2	44,4	16	45,5	50,4
DH158	3/8"	M15	20,0	6,0	19,8	26,1	52,1	19	52,7	58,4

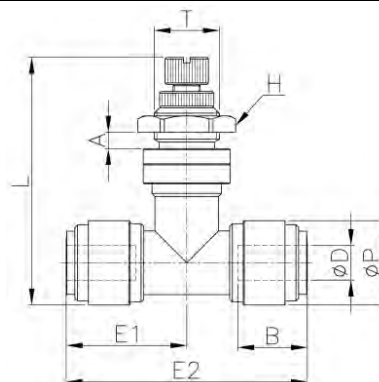



- Suitable for residential R.O. and filtration systems;
- Designed for water, food and air contact but can be used with selected gases, vacuum & other liquids;
- DM 174 (Italy) dated 06/04/2004 compliant about materials suitable for contact with water for human consumption;
- In compliance with the sanitary certification ACS (France);
- In acetal resin grey color, non-toxic and NSF approved material;
- Pressure max 16 bar @ 25°C.

FLOW REGULATORS

REF.	Ø D CONNECTION (inch)	Ø P (mm)	B (mm)	L min (mm)	L max (mm)	E 1 (mm)	E 2 (mm)
DH167	1/4"	15,5	16,9	45,5	42,7	22,2	44,4
DH168	3/8"	20,0	19,8	57,8	49,7	26,1	52,1

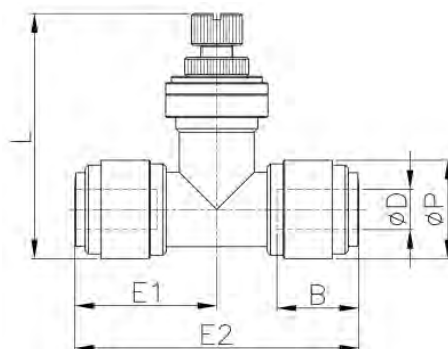

LOCKING CLIPS

REF.	Ø D CONNECTION (inch)	Ø C (mm)	E (mm)	L (mm)	H (mm)	J (mm)	K (mm)
DH193	06 - 1/4"	8,0	11,6	11,6	3,1	6,4	1,3
DH195	10 - 3/8"	11,8	16,0	16,4	3,4	9,2	1,4

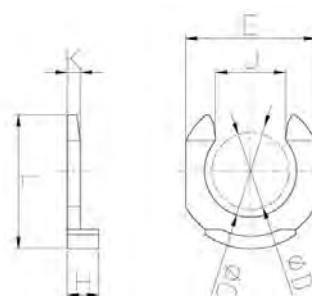

PRF-RO Reverse Osmosis System



- Suitable for residential and commercial application use;
- Compact and reliable system that better suits the flow requirements of small and mid-sized businesses;
- No storage tank needed;
- Works with Line Pressure;
- No Pump or Electricity;
- Very easy installation with quick connections;
- Virtually Maintenance Free (change cartridges fast and easy);
- Consisting of Nr.1 Carbon Pre-Filter, Nr.2 R.O. Membrane Elements and Nr.1 Carbon Post-Filter.



OPERATING CONDITIONS	MINIMUM	MAXIMUM
Inlet Pressure	2,8 bar (40 psi)	5,5 bar (80 psi)
Inlet Temperature (°C)	4	38
Inlet TDS (mg/l)	50	2.000
Inlet Hardness (°F)	0	20
Inlet Chlorine (mg/l)	0	1,0
Inlet Iron (mg/l)	0	0,1
Inlet Manganese (mg/l)	0	0,05

Salt Rejection: Minimum 90%, Medium 93%.

TUBING/FITTING DIMENSIONS	
Inlet Tubing (natural tubing)	1/2"
Concentrate Tubing (black tubing)	3/8"
Permeate Tubing (blue tubing)	3/8"
Drain Tubing (red tubing) for airgap installation	1/2"
Drain connection	3/8" or 1/2"
Carbon Post-Filter	3/8" quick disconnect fittings

Filter/Membrane Performance Specifications:

Filter Type	Length (mm)	Diameter (mm)	Flow Rate (lpm)	Flow Rate (gpm)	Average Life (months)
Carbon Pre-Filter	432	74	14,20	3,75	6 (or 19.000 liters)
RO Element	476	80	(*) 0,95	(*) 0,25	24 ÷ 48
Carbon Post-Filter	254	51	2,80	0,75	6 (or 19.000 liters)

(*) @ 3,44 bar T=25°C 750 mg/l NaCl 25% recovery 1 ppm Chlorine inlet

Ref.	P. N.	Description	
DE904	4000462	Kit R.O. PRF-RO System with faucet	
DE906 (*)	4000575	Kit R.O. PRF-RO System without faucet	

(*) available till it will be out-of-stock.

PRF-RO Reverse Osmosis System



Outline Dimensions in Inches (mm):

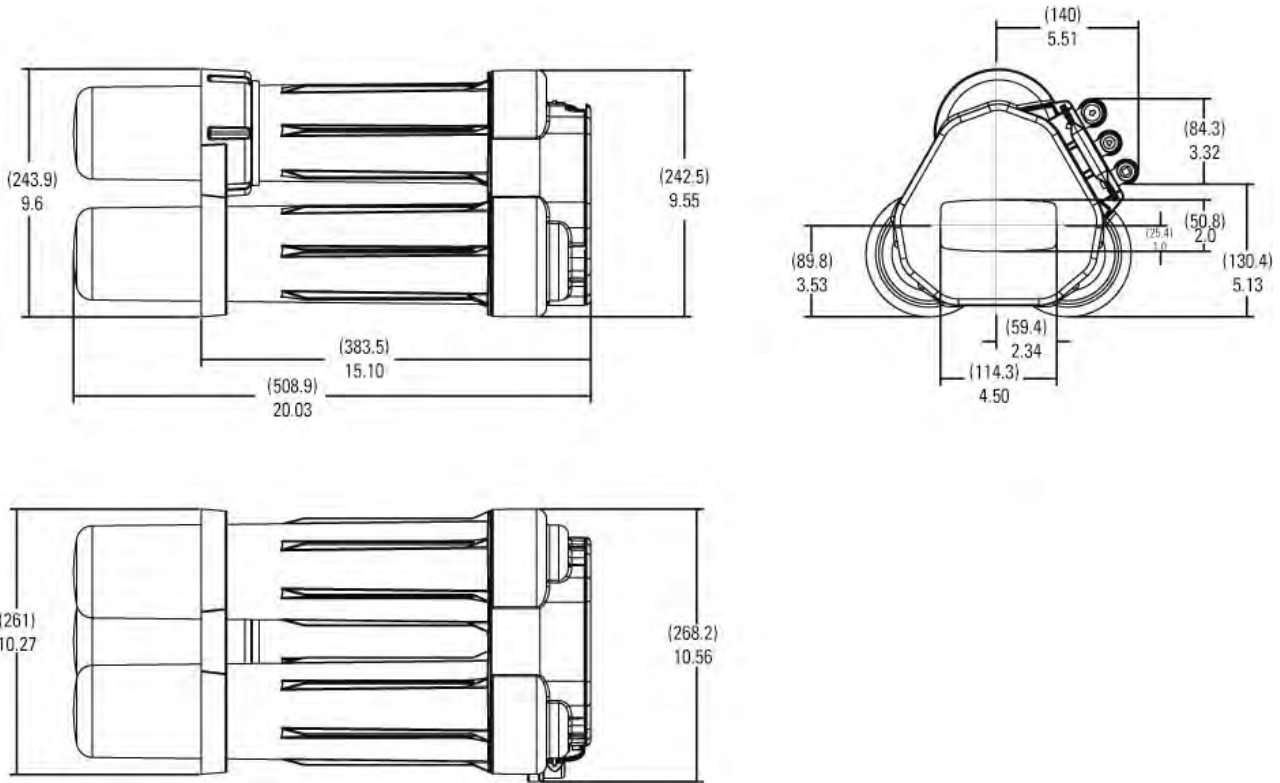

Performance – Flow Rate Characteristics (*)

Based on 750 ppm TDS Inlet Water

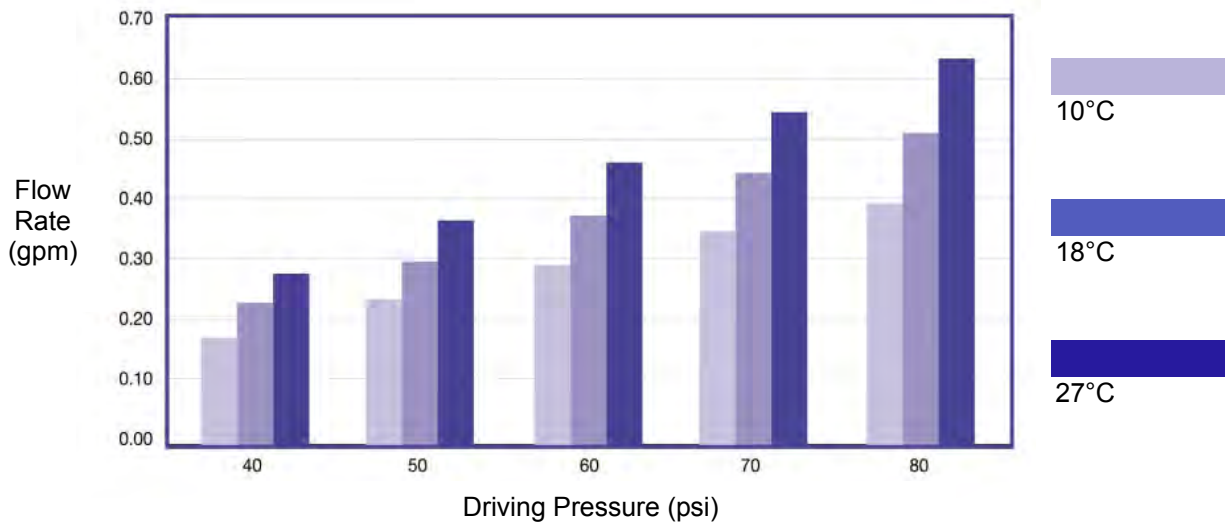

Flow Adjustment Based on TDS

(*) Estimated flow based on internal test data. Actual performance may vary.

PRF-RO Reverse Osmosis System



Spare parts of PRF-RO Reverse Osmosis System:

Ref.	P. N.	Description	
DE920	4000569	PRF-RO Membrane	
DE923	3038333	Carbon pre-filter	
DE924	1266690	Sediment pre-filter 10 micron	
DE926	255526-09	Carbon post-filter	
DE930	1239705	Sump	
DE932	1240326	Sump o-ring	
DE935	4000445	PRF-RO complete manifold	
DE937	3038021	PRF-RO Support Leg	
DE938	1240564	Drain boa kit	
DE941	3038026	Locking bar disconnect	
DE942	3020487	Air-gap faucet kit	
DE945	4000330	PRF-RO kit connection fittings	
DE946	1255736	Tubing install kit	
DE950 (*)	1240620	3/8" black tubing 152 m	
DE951 (*)	1240621	3/8" blue tubing 152 m	
DE952 (*)	1240622	1/2" natural tubing 76 m	
DE953 (*)	1240623	1/2" red tubing 76 m	
DE954	1264462	Fitting elbow concentrate 3/8" black	
DE955	12400117	Fitting elbow feed 1/2" white	
DE956	12400118	Fitting elbow permeate 3/8" blue	
DE960	3002791	Tds and temperature meter	
DE961	4000454	PRF-RO retro fit kit	

(*) N.A. = Not Available.