

**EUROTROL**®

WATER TREATMENT COMPONENTS



## Residential R.O. components

INDEX



## In-Line Cartridges

- IN LINE cartridges 1/4" NPT F connections;
- Max pressure = 100 psi (7 bar);
- Max temperature = 35°C;



Ref	Description	Fam.	Subfam.	Disp. Stock	
DE028	IN LINE ACTIVATED CARBON CARTRIDGE 10" x 2"	030	175	•	
DE029	IN-LINE SEDIMENT CARTRIDGE 10" x 2"	030	175	•	

Ref	Diameter (inch)	Lenght (inch)	Version	Flow (gpm)
DE028	2"	10"	Coconut Shell Activated Carbon	0,75
DE029	2"	10"	Sediment	0,75

Box: WxLxH	Box: Q.ty	Box: Weight	Pallet: WxLxH	Pallet: Q.ty	Pallet: Weight

Certificates	Manufacturer	Sectors
DM174-2004	<b>MWG</b>	Domestic

Ref	Description	Fam.	Subfam.	Disp. Stock	
DE030	IN-LINE ACTIVATED CARBON CARTRIDGE 11" x 2.1/2"	030	175	•	
DE031	IN-LINE SEDIMENT CARTRIDGE 11" x 2.1/2"	030	175	•	

Ref	Diameter (inch)	Lenght (inch)	Version	Flow (gpm)
DE030	2½"	11"	Coconut Shell Activated Carbon	1,00
DE031	2½"	11"	Sediment	1,00

Box: WxLxH	Box: Q.ty	Box: Weight	Pallet: WxLxH	Pallet: Q.ty	Pallet: Weight

Certificates	Manufacturer	Sectors
DM174-2004	<b>MWG</b>	Domestic



## Clips - Valves - Tubing

**Single Mounting Clips:** PP material - white colour.



Ref	Description	Fam.	Subfam.	Disp. Stock	
DE033	SINGLE CLIP 2"	030	175	•	
DE034	SINGLE CLIP 2.5"	030	175	•	
DE006	SINGLE CLIP 3"	030	175	•	

Ref	Description	Diameter (mm)
DE033	SINGLE CLIP 2"	50
DE034	SINGLE CLIP 2.5"	60
DE006	SINGLE CLIP 3"	90

Certificates	Manufacturer	Sectors
		Domestic



**Double Mounting Clips:** PP material - white colour

Ref	Description	Fam.	Subfam.	Disp. Stock	
DE035	DOUBLE CLIPS 2" x 2.5"	030	175	•	
DE036	DOUBLE CLIPS 2.1/2"x2.1/2"	030	175	•	

Ref	Description	Diameter (mm)
DE035	DOUBLE CLIPS 2" x 2.5"	50 x 60
DE036	DOUBLE CLIPS 2.1/2"x2.1/2"	60 x 60

Certificates	Manufacturer	Sectors
		Domestic



## MWG High Pressure Switch



Pressure switch contact NO; Connection 1/4" G; Body material in Stainless Steel; Diaphragm in NBR; Max Voltage = 42 V; Max Current = 4 A; Max operating pressure = 150 bar; Operating temperature range = - 40 ÷ + 100°C Class protection IP54; Conform with CE safety Directives;

Ref	Description	Fam.	Subfam.	Disp. Stock	
DH571	MWG HIGH PRESSURE SWITCH 1-10 BAR	030	175	•	
DH573	MWG HIGH PRESSURE SWITCH 1-20 BAR	030	175	•	
DH575	MWG HIGH PRESSURE SWITCH 20-50 BAR	030	175	•	

Ref	Description	Tolerance
DH571	MWG HIGH PRESSURE SWITCH 1-10 BAR	± 0,5 bar
DH573	MWG HIGH PRESSURE SWITCH 1-20 BAR	± 1 bar
DH575	MWG HIGH PRESSURE SWITCH 20-50 BAR	± 2 bar

Box: WxLxH	Box: Q.ty	Box: Weight	Pallet: WxLxH	Pallet: Q.ty	Pallet: Weight

Certificates	Manufacturer	Sectors
DM174-2004 CE	<b>MWG</b>	Domestic, Commercial, Industrial

## MWG Booster Pumps for Residential R.O.

- MWG booster pumps for residential R.O. Systems;
- Membrane booster pumps without transformer (to order separately);
- IN/OUT connections 3/8" F;



Ref	Description	Fam.	Subfam.	Disp. Stock	
DH501	BOOSTER PUMP M100G 1.1 LPM 24VDC 1.2A	030	175	•	
DH503	BOOSTER PUMP L200G 1.6 LPM 24VDC 1.6A	030	175	•	
DH505	BOOSTER PUMP L400G 2.6 LPM 24VDC 2.5A	030	175	•	

Ref	Ref Trasformatore	Inle pressure (psl)	Working pressure range (psl)	Flow 70 psi (l/min)	Rated current (A)	Current 70 psi (A)
DH501	DH531	30	60 ÷ 80	≥ 1,1	1,8	≤ 1,2
DH503	DH533	30	60 ÷ 80	≥ 1,6	2,2	≤ 1,6
DH505	DH535	30	70 ÷ 90	≥ 2,6	3,6	≤ 2,5

Box: WxLxH	Box: Q.ty	Box: Weight	Pallet: WxLxH	Pallet: Q.ty	Pallet: Weight

Certificates	Manufacturer	Sectors
DM174-2004 CE	<b>MWG</b>	Domestic

## Transformer

Ref	Description	Fam.	Subfam.	Disp. Stock	
DH531	TRANSFORMER 24VDC 2A	030	175	•	
DH533	TRANSFORMER 24VDC 2.5A	030	175	•	
DH535	TRANSFORMER 24VDC 4A	030	175	•	

Box: WxLxH	Box: Q.ty	Box: Weight	Pallet: WxLxH	Pallet: Q.ty	Pallet: Weight

Certificates	Manufacturer	Sectors
CE		Domestic



## MWG Two -Way Solenoid Valves for R.O. Systems



Two-way solenoid valve NC direct acting; Body material plastic; Seals in EPDM; Spring in SS304; Range water temperature = 4°C ÷ 120°C; Range ambient temperature = -10°C ÷ +40°C; Range pressure = 0 ÷ 8 bar; Class protection IP65; Connections 1/4" NPT; Orifice diameter 2,5 mm;

Ref	Description	Fam.	Subfam.	Disp. Stock	
DH601	MWG PLASTIC SOLENOID VALVE NC 1/4" NPT 24V DC	030	175	•	
DH603	MWG PLASTIC SOLENOID VALVE NC 1/4" NPT 24V AC	030	175	•	

Ref	Description	Power supply
DH601	MWG PLASTIC SOLENOID VALVE NC 1/4" NPT 24V DC	24 V DC
DH603	MWG PLASTIC SOLENOID VALVE NC 1/4" NPT 24V AC	220 V AC

Certificates	Manufacturer	Sectors
DM174-2004 CE	<b>MWG</b>	Domestic



Two-way solenoid valve NC direct acting; Body material brass; Seals in EPDM; Range water temperature = 4°C ÷ 120°C; Class protection IP65; G thread connections;

Ref	Description	Fam.	Subfam.	Disp. Stock	
DH611	MWG BRASS SOLENOID VALVE NC 1/4" GAS 24V DC	030	175	•	
DH615	MWG BRASS SOLENOID VALVE NC 3/8" GAS 220V AC 5 BAR	030	175	•	

Ref	Orifice diameter (mm)	Max operating pressure (bar)
DH611	5	5
DH615	5	5

Certificates	Manufacturer	Sectors
DM174-2004 CE	<b>MWG</b>	Domestic, Commercial, Industrial



Two-way solenoid valve NC indirect acting; Body material brass; Seals in EPDM; Range water temperature = 4°C ÷ 120°C; Class protection IP65; G thread connections;

Ref	Description	Fam.	Subfam.	Disp. Stock	
DH621	MWG BRASS SOLENOID VALVE NC 3/8" GAS 220V AC 16 BAR	030	175	•	
DH623	MWG BRASS SOLENOID VALVE NC 1/2" GAS 220V AC	030	175	•	
DH625	MWG BRASS SOLENOID VALVE NC 3/4" GAS 220V AC	030	175	•	
DH627	MWG BRASS SOLENOID VALVE NC 1" GAS 220V AC	030	175	•	
DH629	MWG BRASS SOLENOID VALVE NC 1 1/4" GAS 220V AC	030	175	•	
DH631	MWG BRASS SOLENOID VALVE NC 1 1/2" GAS 220V AC	030	175	•	
DH633	MWG BRASS SOLENOID VALVE NC 2" GAS 220V AC	030	175	•	

Ref	Orifice diameter (mm)	Max operating pressure (bar)
DH621	15	16
DH623	15	16
DH625	20	16
DH627	25	16
DH629	35	16
DH631	35	16
DH633	50	16

Certificates	Manufacturer	Sectors
DM174-2004 CE	<b>MWG</b>	Domestic, Commercial, Industrial



## Valves for Residential R.O. and Filtration System

### Needle Valves

Needle valve for residential R.O and filtration systems; for tube 1/2" M/F or 3/8" M/F; connection for 1/4" or 3/8" or 5/16" flexible tubing; material brass.



Ref	Description	Fam.	Subfam.	Disp. Stock	
DE039	NEEDLE VALVE 1/2" MF X 1/4 TUBE	030	175	•	
DE050	NEEDLE VALVE 1/2" MF X 3/8 TUBE	030	175	•	
DE050A	NEEDLE VALVE 1/2" MF X 5/16" TUBE	030	175	•	
DE039A	NEEDLE VALVE 3/8" M/F x1/4" TUBE	030	175	•	

## Drain and Diverter Valves for R.O. Systems

Suitable for residential R.O and filtration systems.

**Drain Clamp** - material ABS black.



Ref	Description	Fam.	Subfam.	Disp. Stock	
DE040	DRAIN CLAMP 1/4" TUBE	030	175	•	
DE049	DRAIN CLAMP 1/4" FEMALE NPT	030	175	•	

### Diverter Valve with Swivel Collar

Connection for 1/4" tubing; material chrome plated brass.



Ref	Description	Fam.	Subfam.	Disp. Stock	
DE042	DIVERTER VALVE W/SWIVEL COLLAR 1/4" TUBE	030	175	•	

### Adapter 15/16" - 27 X 55/64" - 27

Length 8 mm; material chrome plated brass.



Ref	Description	Fam.	Subfam.	Disp. Stock	
DE043	ADAPTER 15/16" x 55/64"	030	175	•	



## Jaco Style Fittings

Jaco Style Fittings

### Straight



Ref	Description	Fam.	Subfam.	Disp. Stock	
DE063	ELBOW FITTING 1/8"NPT x 1/4"TUBE	030	175	•	
DE064	ELBOW FITTING 1/4"NPT x 1/4"TUBE	030	175	•	
DE068	STRAIGHT FITTING 1/4" F NPT X1/4" TUBE	030	175	•	
DE069	STRAIGHT FITTING 3/8" NPT X1/4" TUBE	030	175	•	

### Elbows



Ref	Description	Fam.	Subfam.	Disp. Stock	
DE060	ELBOW FITTING 1/8" NPT x 1/4" TUBE	030	175	•	
DE062	ELBOW FITTING 1/8" FNPT x 1/4" TUBE	030	175	•	
DE061	ELBOW FITTING 1/4" NPT x 1/4" TUBE	030	175	•	
DE070	ELBOW FITTING 3/8" NPT X 1/4" TUBE	030	175	•	

### Tees



Ref	Description	Fam.	Subfam.	Disp. Stock	
DE065	TEES FITTING 1/4" NPT LATERAL X1/4" TUBE	030	175	•	
DE066	TEES FITTING 1/4" NPT CENTRAL X1/4" TUBE	030	175	•	
DE067	TEES FITTING 1/4" TUBE	030	175	•	



## Valves for Residential R.O. and Filtration System



### Saddle Valve

Saddle valve self piercing for residential R.O and filtration systems; suitable for copper piping; connection for 1/4" tubing; material brass with aluminium clamp.

Ref	Description	Fam.	Subfam.	Disp. Stock	
DE041	NEEDLE VALVE 1/4" TUBE	030	175	•	

## Flow Restrictors - Check Valves



### In-Line Flow Restrictors

Quick connections 1/4" tube.

Ref	Description	Fam.	Subfam.	Disp. Stock	
DE105	IN LINE FLOW RESTRICTOR 150 MLM - 1/4" TUBE	030	175	•	
DE106	IN LINE FLOW RESTRICTOR 300 MLM - 1/4" TUBE	030	175	•	
DE107	IN LINE FLOW RESTRICTOR 400 MLM - 1/4" TUBE	030	175	•	
DE108	IN LINE FLOW RESTRICTOR 550 MLM - 1/4" TUBE	030	175	•	
DE109	IN LINE FLOW RESTRICTOR 600 MLM - 1/4" TUBE	030	175	•	
DE110	IN LINE FLOW RESTRICTOR 800 MLM - 1/4" TUBE	030	175	•	

Ref	Flow 60 psi (gpd)	Flow 60 psi (ml/min)
DE105	60	150
DE106	115	300
DE107	150	400
DE108	208	550
DE109	227	600
DE110	300	800





### JACO Style Check Valve

Jaco style elbow 1/8" x 1/4" tube complete with AISI check-valve.

Ref	Description	Fam.	Subfa m.	Disp. Stock	
DE079	ELBOW 1/8"X1/4" TUBE W/STAINLESS STEEL CHECK VALVE	030	175	•	



### S.S. Check Valve

Stainless steel check valve 1/8" x 1/8" ..

Ref	Description	Fam.	Subfa m.	Disp. Stock	
DE048	CHECK-VALVE S.S. 1/8" NPT	030	175	•	



### Elbowed Ball Valve

Material white plastic; connections 1/4" F NPT x 1/4" tubing.

Ref	Description	Fam.	Subfa m.	Disp. Stock	
DE052	ELBOWED BALL VALVE 1/4" F NPTx1/4" TUBE	030	175	•	



### Automatic Shut-Off Valve

Material white ABS; connections 1/4" tubing; max pressure 125 psi (8,5 bar).

Ref	Description	Fam.	Subfa m.	Disp. Stock	
DE038	SHUT-OFF VALVE 1/4" TUBE	030	175	•	



### Mechanical Flow Meter

Adjustable setting; automatic shut-off based on volume; capacity 7000 litres; connections 1/4" NPT; operating pressure 1 ÷ 8,5 bar; material ABS, black colour.

Ref	Description	Fam.	Subfa m.	Disp. Stock	
DE080	MECHANICAL FLOW METER 1/4" NPT	030	175	•	



## Storage Tanks for R.O. Systems

### PP Storage Tanks

- Pressurized storage tank for treated water;
- White colour;
- Connection 1/4" NPT;
- Min. operating pressure 1 bar.



Ref	Description	Fam.	Subfam.	Disp. Stock	
DE032	PP/SS R.O STORAGE TANK 12 LT.	030	175	•	
DE051	PLASTIC R.O STORAGE TANK 16 LT.	030	175	•	

Ref	Diameter (mm)	Height (mm)	Max pressure (bar)
DE032	240	370	7,0
DE051	260	400	3,5

Box: WxLxH	Box: Q.ty	Box: Weight	Pallet: WxLxH	Pallet: Q.ty	Pallet: Weight

Certificates	Manufacturer	Sectors
NSF58 CE		Domestic

### Steel Storage Tanks

- Pressurized storage tank for R.O water;
- Material painted steel, white colour;
- Connection 1" BSPP female;
- With threaded extension M 1" x 1/4", with elbowed ball valve with connection 3/8" tubing;
- Min. operating pressure 1 bar;
- Max operating pressure 7 bar.



Ref	Description	Fam.	Subfam.	Disp. Stock	
DE096	S.S. RO STORAGE TANK 41 LT.	030	175	•	
DE097	S.S. RO STORAGE TANK 75 LT.	030	175	•	

Ref	Diameter (mm)	Height (mm)
DE096	390	575
DE097	390	770

Box: WxLxH	Box: Q.ty	Box: Weight	Pallet: WxLxH	Pallet: Q.ty	Pallet: Weight

Certificates	Manufacturer	Sectors
NSF58 CE		Domestic

## In-Line Cartridges

### R.O. compact assembly and accessories

Ref	Description	Fam.	Subfam.	Disp. Stock	
DE100	R.O. COMPACT GROUP	030	175	•	
DE101	MEMBRANE 50 GPD FOR DE100	030	175	•	
DE102A	PREFILTER CARTRIDGE SEDIMENT/CARBON BLOCK FOR EMPTY COMPACT R.O. ASSEMBLY	030	175	•	
DE103	GAC POSTFILTER CARTRIDGE FOR EMPTY COMPACT R.O. ASSEMBLY	030	175	•	



## Permeate Pump for Residential R.O. Systems



- Using the energy of the brine water of the R.O. system to pump the permeate into the pressure tank, increases the net operating pressure on the membrane and eliminate the negative effect of the pressure on the storage tank;
- Hydraulic pump, does not require electricity;
- For residential R.O. systems with pressurized storage tank and membrane from 35 to 100 GPD;
- The permeate pump can increase up to 5 time the system recovery, reducing the water consumption and the refill time of the storage tank;
- No shut-off valve is needed;
- Materials polypropylene/ EPDM;
- Max operating pressure 6,8 bar;
- Connections for ¼" tubing;
- Max drain flow rate 0,8 l/min.

Ref	Description	Fam.	Subfam.	Disp. Stock	
DE120	PERMEATE PUMP	030	175	•	

### Accessories



Ref	Description	Fam.	Subfam.	Disp. Stock	
DE121	PERMEATE PUMP SINGLE CLIP	030	175	•	



### Flexible 1/4" Tubing

Ref	Description	Fam.	Subfam.	Disp. Stock	
DE082	PVC TUBE WHITE 1/4" - ROLL 50 MT.	030	175	•	
DE083	PE TUBE BLUE 1/4" - ROLL 50 MT.	030	175	•	
DE084	PE TUBE BLACK 1/4" ROLL 50 MT.	030	175	•	
DE086	PE TUBE RED 1/4" - ROLL 50 MT.	030	175	•	
DE081	PE TUBE CLEAR 1/4" - ROLL 100 MT.	030	175	•	



### Insert for Flexible 1/4" Tubing: CELCON material.

Ref	Description	Fam.	Subfam.	Disp. Stock	
DE059	PLASTIC INSERT FOR 1/4" TUBE	030	175	•	

### Flow Restrictor Linear Type

- Capillary adjusting flow system with insertion in tube 1/4" diameter ( $\varnothing e=6,35$  mm);
- 200 mm standard length; you can change the length as required (please see the diagram below);
- **WARNING:** it is essential that the cutting of the capillary be neat and tube perfectly circular (you can use an awl in order to restore the circular form), otherwise the flow rate value can be greatly altered. Observe the flow direction as shown in Picture n.1.

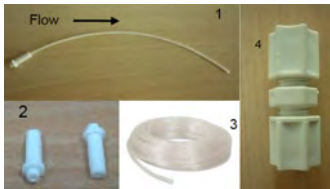

Ref	Description	Fam.	Subfam.	Disp. Stock	
DE122	FLOW RESTRICTOR LINEAR TYPE - LG.200 MM	030	175	•	
DE124	FLOW RESTRICTOR FRT-14P INSERT	030	175	•	
DE125	CAPILLARY TUBE ROLL 25 MT	030	175	•	
DE123	FLOW RESTRICTOR JACO 1/4" UNION*	030	175	•	

ITEM	Ref	Description
1	DE122	FLOW RESTRICTOR LINEAR TYPE - LG.200 MM
2	DE124	FLOW RESTRICTOR FRT-14P INSERT
3	DE125	CAPILLARY TUBE ROLL 25 MT
4	DE123	FLOW RESTRICTOR JACO 1/4" UNION*



## Faucet

### Long Reach Faucet

- material chrome plated; connection for ¼" tubing; complete with installation kit; threaded tube length 50 mm.

Ref	Description	Fam.	Subfam.	Disp. Stock	
DE037	LONG REACH FAUCET 1/4" TUBE	030	175	•	

Certificates	Manufacturer	Sectors
		Domestic



### Quarter-Turn faucet

- metal and plastic chrome material; connection for ¼" tubing;
- complete with installation kit; threaded tube length 71 mm;

Ref	Description	Fam.	Subfam.	Disp. Stock	
DE116	QUARTER - TURN FAUCET 1/4" TUBE	030	175	•	

Certificates	Manufacturer	Sectors
		Domestic



### Single Handle Faucet with Drinking Nozzle

- monobloc, material chrome plated;
- adjustable necks;
- hot and cold water connections ½" with needle valves; treated water connection ¼" tube;
- complete with installation kit.

Ref	Description	Fam.	Subfam.	Disp. Stock	
DE087	SINGLE HEAD FAUCET W/DRINKING NOZZLE	030	175	175	

Certificates	Manufacturer	Sectors
		Domestic





## Pressure Gauge - Adapters - Valves

### Pressure Gauge

- pressure set 0 ÷ 10 bar;
- connection 1/8" M;
- diameter 25 mm.



Ref	Description	Fam.	Subfam.	Disp. Stock	
DE077	MANOMETER D.25 0-10 KG/CM2 1/8"	030	175	•	

Certificates	Manufacturer	Sectors
		Domestic

### 3 Ways Adapter for Pressure Gauge

- plastic material;
- connections 1/8" F x 1/8" M x 1/4" tube.



Ref	Description	Fam.	Subfam.	Disp. Stock	
DE078	3-WAYS FITTING FOR MANOMETER 1/8 F X 1/8 M X 1/4 TUBO	030	175	•	

Certificates	Manufacturer	Sectors
		Domestic



## Fittings

- Suitable for residential R.O. and filtration systems;
- Designed for water, food and air contact but can be used with selected gases, vacuum & other liquids;
- In compliance with the sanitary certification ACS (France);
- In acetal resin grey color, non-toxic and NSF approved material;
- Pressure max 16 bar @ 25°C.

### Male connector NPTF

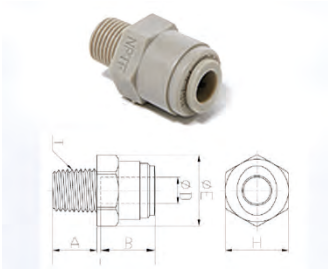

Ref	Description	Fam.	Subfam.	Disp. Stock	
DH005	MALE CONNECTOR 1/8" NPT WITH D=1/4"	030	175	•	
DH006	MALE CONNECTOR 1/4" NPT WITH D=1/4"	030	175	•	
DH007	MALE CONNECTOR 3/8" NPT WITH D=1/4"	030	175	•	
DH012	MALE CONNECTOR 1/8" NPT WITH D=3/8"	030	175	•	
DH013	MALE CONNECTOR 1/4" NPT WITH D=3/8"	030	175	•	
DH014	MALE CONNECTOR 3/8" NPT WITH D=3/8"	030	175	•	

Ref	A (mm)	B (mm)	Ø E (mm)	H (mm)	L (mm)
DH005	9,1	16,9	17,8	15,8	27,0
DH006	13,2	16,9	17,8	15,8	27,0
DH007	13,8	16,9	21,4	19,0	26,1
DH012	9,1	20,2	23,0	20,6	30,4
DH013	13,2	20,2	23,0	20,6	34,3
DH014	13,8	20,2	23,0	20,6	29,9

### Female adapter NPTF



Ref	Description	Fam.	Subfam.	Disp. Stock	
DH021	FEMALE ADAPTER 1/8" NPT WITH D=1/4"	030	175	•	
DH022	FEMALE ADAPTER 1/4" NPT WITH D=1/4"	030	175	•	
DH023	FEMALE ADAPTER 1/4" NPT WITH D=3/8"	030	175	•	

Ref	Ø P (mm)	A (mm)	B (mm)	Ø E (mm)	H (mm)	L (mm)
DH021	15,5	11,5	16,9	19,0	17	30,9
DH022	15,5	11,5	16,9	21,5	19	30,9
DH023	20,0	11,5	20,2	21,5	19	34,2

### Male elbow NPT



Ref	Description	Fam.	Subfam.	Disp. Stock	
DH033	MALE ELBOW 1/8" NPT WITH D=1/4"	030	175	•	
DH034	MALE ELBOW 1/4" NPT WITH D=1/4"	030	175	•	
DH035	MALE ELBOW 3/8" NPT WITH D=1/4"	030	175	•	
DH038	MALE ELBOW 1/4" NPT WITH D=3/8"	030	175	•	
DH039	MALE ELBOW 3/8" NPT WITH D=3/8"	030	175	•	

Ref	Ø P (mm)	A (mm)	B (mm)	E (mm)	H (mm)	L (mm)
DH033	15,5	9,1	16,9	26,4	11,0	25,6
DH034	15,5	13,2	16,9	31,9	11,0	27,0
DH035	15,5	13,8	16,9	32,7	11,0	28,9
DH038	20,0	13,2	20,2	35,2	14,3	31,8
DH039	20,0	13,8	20,2	35,8	14,3	33,9

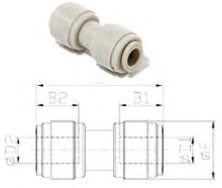

## Union connector

Ref	Description	Fam.	Subfam.	Disp. Stock
DH073	UNION CONNECTOR 1/4" - 1/4"	030	175	•
DH075	UNION CONNECTOR 3/8" - 3/8"	030	175	•
DH079	UNION CONNECTOR 3/8" - 1/4"	030	175	•

Ref	B1 (mm)	B2 (mm)	Ø E (mm)	L (mm)
DH073	16,9	16,9	15,5	36,2
DH075	20,2	20,2	20,0	42,9
DH079	20,2	16,9	20,0	42,1



## Union elbow

Ref	Description	Fam.	Subfam.	Disp. Stock
DH083	UNION ELBOW 1/4" - 1/4"	030	175	•
DH085	UNION ELBOW 3/8" - 3/8"	030	175	•

Ref	B1 (mm)	B2 (mm)	Ø E 1 (mm)	Ø E 2 (mm)	L (mm)	H (mm)
DH083	16,9	16,9	15,5	15,5	28,8	28,8
DH085	20,2	20,2	20,0	20,0	35,9	35,9

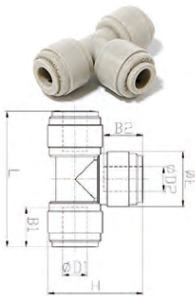

## Union T

Ref	Description	Fam.	Subfam.	Disp. Stock
DH093	UNION TEE 1/4" - 1/4" - 1/4"	030	175	•
DH095	UNION TEE 3/8" - 3/8" - 3/8"	030	175	•

Ref	B1 (mm)	B2 (mm)	B3 (mm)	Ø E (mm)	L (mm)	H (mm)
DH093	16,9	16,9	16,9	15,5	42,0	28,8
DH095	20,2	20,2	20,2	20,0	51,8	35,9

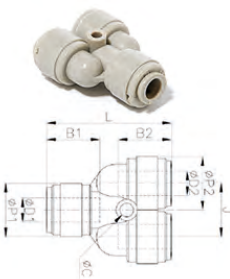

## Two way divider

Ref	Description	Fam.	Subfam.	Disp. Stock
DH103	TWO WAY DIVIDER 1/4" - 1/4" - 1/4"	030	175	•
DH105	TWO WAY DIVIDER 3/8" - 3/8" - 3/8"	030	175	•

Ref	B1 (mm)	B2 (mm)	Ø P1 (mm)	Ø P2 (mm)	L (mm)	J (mm)	C (mm)
DH103	16,9	16,9	15,5	15,5	38,8	15,5	3,3
DH105	20,2	20,2	20,0	20,0	46,4	20,0	4,5





## Fittings

### Bulkhead connector

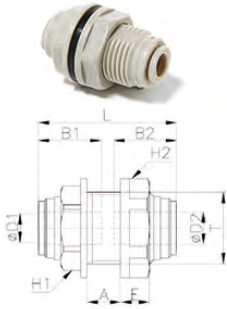

Ref	Description	Fam.	Subfam.	Disp. Stock	
DH052	BULKHEAD CONNECTOR 1/4" - 1/4"	030	175	•	
DH054	BULKHEAD CONNECTOR 3/8" - 3/8"	030	175	•	

Ref	T	B1 (mm)	B2 (mm)	H1 (mm)	H2 (mm)	L (mm)
DH052	M17	16,9	16,9	19	21	35,7
DH054	M24	20,2	20,2	24	25,5	42,4

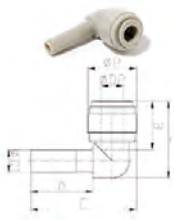

### Union elbow tube with stem

Ref	Description	Fam.	Subfam.	Disp. Stock	
DH063	UNION ELBOW TUBE WITH STEM 1/4" - 1/4"	030	175	•	
DH065	UNION ELBOW TUBE WITH STEM 3/8" - 3/8"	030	175	•	
DH067	UNION ELBOW TUBE WITH STEM 3/8" - 1/4"	030	175	•	

Ref	Ø P (mm)	A (mm)	B (mm)	E (mm)	L (mm)
DH063	15,5	21,0	16,9	34,8	25,1
DH065	20,0	24,8	20,2	43,2	31,4
DH067	17,6	22,5	17,5	38,3	27,7



### Union connector

Ref	Description	Fam.	Subfam.	Disp. Stock	
DH073	UNION CONNECTOR 1/4" - 1/4"	030	175	•	
DH075	UNION CONNECTOR 3/8" - 3/8"	030	175	•	
DH079	UNION CONNECTOR 3/8" - 1/4"	030	175	•	

Ref	B1 (mm)	B2 (mm)	Ø E (mm)	L (mm)
DH073	16,9	16,9	15,5	36,2
DH075	20,2	20,2	20,0	42,9
DH079	20,2	16,9	20,0	42,1



### Bulkhead flow regulators

Ref	Description	Fam.	Subfam.	Disp. Stock	
DH157	BULKHEAD FLOW REGULATOR WITH D=1/4"	030	175	•	
DH158	BULKHEAD FLOW REGULATOR WITH D=3/8"	030	175	•	

Ref	T	Ø P (mm)	A (mm)	B (mm)	E1 (mm)	E2 (mm)	H (mm)	L min (mm)	L max (mm)
DH157	M12	15,5	5,0	16,9	22,2	44,4	16	45,5	50,4
DH158	M15	20,0	6,0	19,8	26,1	52,1	19	52,7	58,4



## Fittings

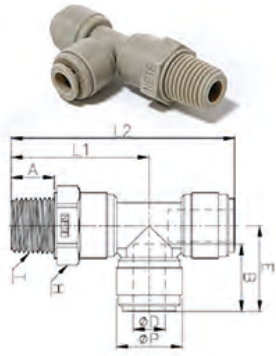

- Suitable for residential R.O. and filtration systems;
- Designed for water, food and air contact but can be used with selected gases, vacuum & other liquids;
- In compliance with the sanitary certification ACS (France);
- In acetal resin grey color, non-toxic and NSF approved material;
- Pressure max 16 bar @ 25°C.

### Male Swivel run tee NPTF

Ref	Description	Fam.	Subfam.	Disp. Stock
DH122	MALE SWIVEL RUN TEE 1/4" NPT WITH D=1/4"	030	175	•
DH124	MALE SWIVEL RUN TEE 3/8" NPT WITH D=3/8"	030	175	•

Ref	Ø P (mm)	A (mm)	B (mm)	E (mm)	H (mm)	L <sup>1</sup> (mm)	L <sup>2</sup> (mm)
DH122	15,5	13,2	16,9	21,0	17,46	36,9	57,9
DH124	20,0	13,0	20,2	25,9	21,4	41,8	67,7

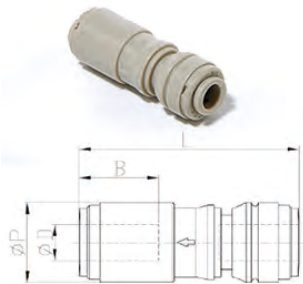

### Check valves

Ref	Description	Fam.	Subfam.	Disp. Stock
DH131	CHECK VALVES 1/4"	030	175	•
DH133	CHECK VALVES 3/8"	030	175	•

Ref	Ø P (mm)	B (mm)	L (mm)
DH131	15,5	16,1	45,5
DH133	20,0	19,5	57,8

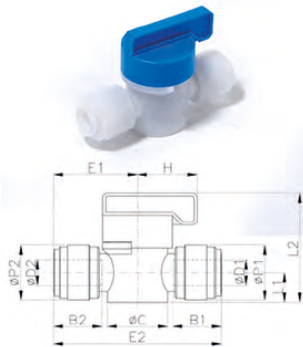

### 2 ways hand valves

Ref	Description	Fam.	Subfam.	Disp. Stock	PriceEuro
DH141	2 WAYS HAND VALVES 1/4"	030	175	•	
DH143	2 WAYS HAND VALVES 3/8"	030	175	•	

Ref	Ø D1 Connection (inch)	Ø D2 Connection (inch)	B1 (mm)	B2 (mm)	Ø P1 (mm)	Ø P2 (mm)	L1 (mm)	L2 (mm)	E (mm)	Ø C (mm)
DH141	1/4"	1/4"	16,1	16,1	15,5	15,5	9,5	34,5	51,7	19,2
DH143	3/8"	3/8"	20,2	20,2	20,2	20,2	12,5	42,3	63,2	24,2



## Fittings

### Flow regulators

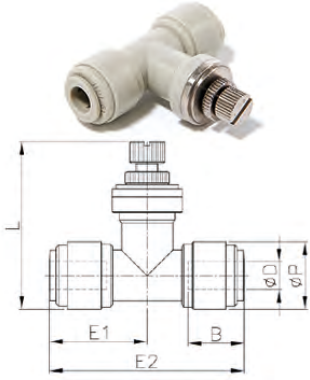

Ref	Description	Fam.	Subfam.	Disp. Stock	
DH167	FLOW REGULATOR WITH D=1/4"	030	175	•	
DH168	FLOW REGULATOR WITH D=3/8"	030	175	•	

Ref	ø P (mm)	B (mm)	L min (mm)	L max (mm)	E1 (mm)	E2 (mm)
DH167	15,5	16,9	45,5	42,7	22,2	44,4
DH168	20,0	19,8	57,8	49,7	26,1	52,1

### Locking clips

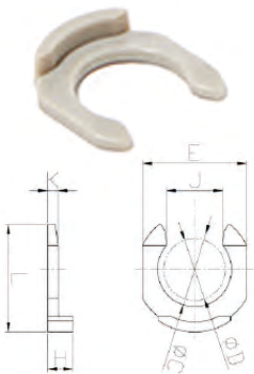

Ref	Description	Fam.	Subfam.	Disp. Stock	
DH193	LOCKING CLIPS FOR FITTINGS 1/4"	030	175	•	
DH195	LOCKING CLIPS FOR FITTINGS 3/8"	030	175	•	

Ref	ø D Connection (inch)	ø C (mm)	E (mm)	L (mm)	H (mm)	J (mm)	K (mm)
DH193	06 - 1/4"	8,0	11,6	11,6	3,1	6,4	1,3
DH195	10 - 3/8"	11,8	16,0	16,4	3,4	9,2	1,4

### Male swivel tee NPTF



Ref	Description	Fam.	Subfam.	Disp. Stock	
DH112	MALE SWIVEL TEE 1/4" NPT WITH D=1/4"	030	175	•	
DH114	MALE SWIVEL TEE 3/8" NPT WITH D=3/8"	030	175	•	

Ref	ø P (mm)	A (mm)	B (mm)	E (mm)	H (mm)	L (mm)
DH112	15,5	13,2	16,9	21,0	17,46	36,9
DH114	20,0	13,0	20,2	25,9	21,4	41,8



## PRF-RO Reverse Osmosis System



- Suitable for residential and commercial application use;
- Compact and reliable system that better suits the flow requirements of small and mid-sized businesses;
- No storage tank needed;
- Works with Line Pressure;
- No Pump or Electricity;
- Very easy installation with quick connections;
- Virtually Maintenance Free (change cartridges fast and easy);
- Consisting of Nr.1 Carbon Pre-Filter, Nr.2 R.O. Membrane Elements and Nr.1 Carbon Post-Filter.

Ref	Description	Fam.	Subfam.	Disp. Stock	
DE904	KIT R.O. PRF-RO SYSTEM P/N 4000462 WITH FAUCET	030	179	•	
DE906	KIT R.O. PRF-RO SYSTEM P/N 4000575	030	179		

Ref	P.N.	Description
DE904	4000462	KIT R.O. PRF-RO SYSTEM P/N 4000462 WITH FAUCET
DE906	4000575	KIT R.O. PRF-RO SYSTEM P/N 4000575

OPERATING CONDITIONS	MINIMUM	MAXIMUM
Inlet Pressure	2,8 bar (40 psi)	5,5 bar (80 psi)
Inlet Temperature (°C)	4	38
Inlet TDS (mg/l)	50	2.000
Inlet Hardness (°F)	0	20
Inlet Chlorine (mg/l)	0	1,0
Inlet Iron (mg/l)	0	0,1
Inlet Manganese (mg/l)	0	0,05

**Salt Rejection: Minimum 90%, Medium 93%.**

TUBING/FITTING DIMENSIONS	
Inlet Tubing (natural tubing)	½"
Concentrate Tubing (black tubing)	¾"
Permeate Tubing (blue tubing)	¾"
Drain Tubing (red tubing) for airgap installation	½"
Drain connection	¾" or ½"
Carbon Post-Filter	¾" quick disconnect fittings

### Filter/Membrane Performance Specifications:

Filter Type	Length (mm)	Diameter (mm)	Flow Rate (lpm)	Flow Rate (gpm)	Average Life (months)
Carbon Pre-Filter	432	74	14,20	3,75	6 ( or 19.000 Liters )
RO Element	476	80	0,95	0,25	24 ÷ 48
Carbon Post-Filter	254	51	2,80	0,75	6 ( or 19.000 Liters )

Box: WxLxH	Box: Q.ty	Box: Weight	Pallet: WxLxH	Pallet: Q.ty	Pallet: Weight

Certificates	Manufacturer	Sectors
	Pentair	Domestic, Industrial



## PRF-RO Reverse Osmosis System

### Spare parts of PRF-RO Reverse Osmosis System:

Ref	Description	Fam.	Subfam.	Disp. Stock	
DE920	MEMBRANE R.O. MERLIN P/N 4000569	030	179	•	
DE923	CARBON CARTRIDGE PRE FILTER P/N 3038333	030	179	•	
DE924	PRE FILTER CARTRIDGE SEDIMENT 10 MICRON P/N 1266690	030	179	•	
DE926	CARBON IN LINE POSTFILTER P/N 255526-09	030	179	•	
DE930	SUMP P/N 1239705	030	179		
DE932	SUMP O-RING P/N 1240326	030	179		
DE935	HEAD ASSEMBLY PRF-RO P/N 4000445	030	179		
DE937	SUPPORT SHOULDER PRF-RO P/N 3038021	030	179		
DE938	DRAIN FITTING KIT W/COLLARS P/N 1240564	030	179		
DE941	SAFETY PLATE FOR FITTING FIXING PRF-RO P/N 3038026	030	179		
DE942	AIR-GAP FAUCET P/N 3020487	030	179		
DE945	CONNECTION FITTINGS KIT PRF-RO P/N 4000330	030	179		
DE946	CONNECTION TUBE KIT P/N 1255736	030	179		
DE954	CONCENTRATE ELBOWED FITTING 3/8" BLACK P/N 1264462	030	179		
DE955	FEED ELBOWED FITTING 1/2" WHITE P/N 12400117	030	179		
DE956	PERMEATE ELBOWED FITTING 3/8" BLUE P/N 12400118	030	179		
DE961	RETRO FIT KIT PRF-RO P/N 4000454	030	179		

Ref	P.N.	Description
DE920	4000569	MEMBRANE R.O. MERLIN P/N 4000569
DE923	3038333	CARBON CARTRIDGE PRE FILTER P/N 3038333
DE924	1266690	PRE FILTER CARTRIDGE SEDIMENT 10 MICRON P/N 1266690
DE926	255526-09	CARBON IN LINE POSTFILTER P/N 255526-09
DE930	1239705	SUMP P/N 1239705
DE932	1240326	SUMP O-RING P/N 1240326
DE935	4000445	HEAD ASSEMBLY PRF-RO P/N 4000445
DE937	3038021	SUPPORT SHOULDER PRF-RO P/N 3038021
DE938	1240564	DRAIN FITTING KIT W/COLLARS P/N 1240564
DE941	3038026	SAFETY PLATE FOR FITTING FIXING PRF-RO P/N 3038026
DE942	3020487	AIR-GAP FAUCET P/N 3020487
DE945	4000330	CONNECTION FITTINGS KIT PRF-RO P/N 4000330
DE946	1255736	CONNECTION TUBE KIT P/N 1255736
DE954	1264462	CONCENTRATE ELBOWED FITTING 3/8" BLACK P/N 1264462
DE955	12400117	FEED ELBOWED FITTING 1/2" WHITE P/N 12400117
DE956	12400118	PERMEATE ELBOWED FITTING 3/8" BLUE P/N 12400118
DE961	4000454	RETRO FIT KIT PRF-RO P/N 4000454