

EUROTROL®

WATER TREATMENT COMPONENTS

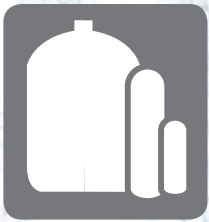

MWG,
STRUCTURAL
pressure vessels
and accessories



MWG Residential Pressure Vessels with Base



- Made in China;
- Composite pressure vessels PE liner reinforced with fiberglass and epoxy resin;
- For industrial and potable water treatment systems;
- European 2014/68/EU Directive compliant for pressure equipment (PED);
- Max operating pressure 10 bar; max operating temperature 50°C;
- Top connection threaded 2 ½" – 8NPSM or 4"– 8UN; Cycle test 250.000 times from 0,7 to 10 bar;
- Burst test to 4 times max operating pressure;
- Blue colour;
- Warranty 10 years.

Ref	Description	Fam.	Subfam.	Disp. Stock	
BMWG05013BB	MWG PRESSURE VESSEL 5X13 2.5" BLUE	43	412	•	
BMWG06013BB	MWG PRESSURE VESSEL 6X13 2.5" BLUE	43	412	•	
BMWG06018BB	MWG PRESSURE VESSEL 6X18 2.5" BLUE	43	412	•	
BMWG06035BB	MWG PRESSURE VESSEL 6X35 2.5" BLUE	43	412	•	
BMWG07013BB	MWG PRESSURE VESSEL 7X13 2.5" BLUE	43	412	•	
BMWG07017BB	MWG PRESSURE VESSEL 7X17 2.5" BLUE	43	412	•	
BMWG07024BB	MWG PRESSURE VESSEL 7X24 2.5" BLUE	43	412	•	
BMWG07030BB	MWG PRESSURE VESSEL 7X30 2.5" BLUE	43	412	•	
BMWG07035BB	MWG PRESSURE VESSEL 7X35 2.5" BLUE	43	412	•	
BMWG08013BB	MWG PRESSURE VESSEL 8X13 2.5" BLUE	43	412	•	
BMWG08017BB	MWG PRESSURE VESSEL 8X17 2.5" BLUE	43	412	•	
BMWG08024BB	MWG PRESSURE VESSEL 8X24 2.5" BLUE	43	412	•	
BMWG08030BB	MWG PRESSURE VESSEL 8X30 2.5" BLUE	43	412	•	
BMWG08035BB	MWG PRESSURE VESSEL 8X35 2.5" BLUE	43	412	•	
BMWG08044BB	MWG PRESSURE VESSEL 8X44 2.5" BLUE	43	412	•	
BMWG09017BB	MWG PRESSURE VESSEL 9X17 2.5" BLUE	43	412	•	
BMWG09030BB	MWG PRESSURE VESSEL 9X30 2.5" BLUE	43	412	•	
BMWG09035BB	MWG PRESSURE VESSEL 9X35 2.5" BLUE	43	412	•	
BMWG09042BB	MWG PRESSURE VESSEL 9X42 2.5" BLUE	43	412	•	
BMWG09048BB	MWG PRESSURE VESSEL 9X48 2.5" BLUE	43	412	•	
BMWG10017BB	MWG PRESSURE VESSEL 10X17 2.5" BLUE	43	412	•	
BMWG10019BB	MWG PRESSURE VESSEL 10X19 2.5" BLUE	43	412	•	
BMWG10024BB	MWG PRESSURE VESSEL 10X24 2.5" BLUE	43	412	•	
BMWG10030BB	MWG PRESSURE VESSEL 10X30 2.5" BLUE	43	412	•	
BMWG10035BB	MWG PRESSURE VESSEL 10X35 2.5" BLUE	43	412	•	
BMWG10044BB	MWG PRESSURE VESSEL 10X44 2.5" BLUE	43	412	•	
BMWG10047BB	MWG PRESSURE VESSEL 10X47 2.5" BLUE	43	412	•	
BMWG10054BB	MWG PRESSURE VESSEL 10X54 2.5" BLUE	43	412	•	
BMWG10054GB	MWG PRESSURE VESSEL 10X54 4" BLUE	43	412	•	
BMWG12048BB	MWG PRESSURE VESSEL 12X48 2.5" BLUE	43	412	•	
BMWG12052BB	MWG PRESSURE VESSEL 12X52 2.5" BLUE	43	412	•	
BMWG13044BB	MWG PRESSURE VESSEL 13X44 2.5" BLUE	43	412	•	
BMWG13054BB	MWG PRESSURE VESSEL 13X54 2.5" BLUE	43	412	•	
BMWG13054GB	MWG PRESSURE VESSEL 13X54 4" BLUE	43	412	•	



MWG Residential Pressure Vessels with Base

Characteristics

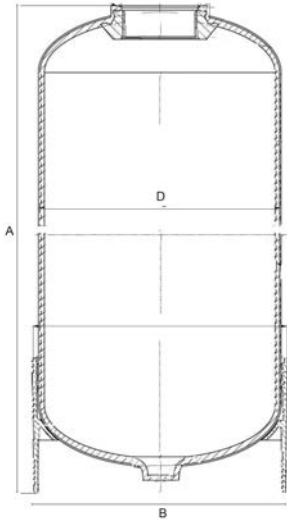

Ref	Description	Volume (Liters)	External D (mm)	A (mm)	B (mm)	Connection
BMWG05013BB	MWG PRESSURE VESSEL 5X13 2.5" BLUE	3,2	130	335 ± 6	135	2½
BMWG06013BB	MWG PRESSURE VESSEL 6X13 2.5" BLUE	4,9	159	335 ± 6	165	2½
BMWG06018BB	MWG PRESSURE VESSEL 6X18 2.5" BLUE	7,2	159	462 ± 6	165	2½
BMWG06035BB	MWG PRESSURE VESSEL 6X35 2.5" BLUE	15,0	159	896 ± 6	165	2½
BMWG07013BB	MWG PRESSURE VESSEL 7X13 2.5" BLUE	6,3	180	333 ± 6	188	2½
BMWG07017BB	MWG PRESSURE VESSEL 7X17 2.5" BLUE	8,6	180	434 ± 6	188	2½
BMWG07024BB	MWG PRESSURE VESSEL 7X24 2.5" BLUE	13,2	180	605 ± 6	188	2½
BMWG07030BB	MWG PRESSURE VESSEL 7X30 2.5" BLUE	16,4	180	768 ± 6	188	2½
BMWG07035BB	MWG PRESSURE VESSEL 7X35 2.5" BLUE	20,1	180	891 ± 6	188	2½
BMWG08013BB	MWG PRESSURE VESSEL 8X13 2.5" BLUE	8,5	207	338 ± 6	216	2½
BMWG08017BB	MWG PRESSURE VESSEL 8X17 2.5" BLUE	10,9	207	439 ± 6	216	2½
BMWG08024BB	MWG PRESSURE VESSEL 8X24 2.5" BLUE	15,9	207	627 ± 6	216	2½
BMWG08030BB	MWG PRESSURE VESSEL 8X30 2.5" BLUE	20,9	207	773 ± 6	216	2½
BMWG08035BB	MWG PRESSURE VESSEL 8X35 2.5" BLUE	25,0	207	898 ± 6	216	2½
BMWG08044BB	MWG PRESSURE VESSEL 8X44 2.5" BLUE	32,6	207	1130 ± 6	216	2½
BMWG09017BB	MWG PRESSURE VESSEL 9X17 2.5" BLUE	13,8	231	456 ± 6	240	2½
BMWG09030BB	MWG PRESSURE VESSEL 9X30 2.5" BLUE	26,9	231	776 ± 6	240	2½
BMWG09035BB	MWG PRESSURE VESSEL 9X35 2.5" BLUE	32,1	231	900 ± 6	240	2½
BMWG09042BB	MWG PRESSURE VESSEL 9X42 2.5" BLUE	38,4	231	1076 ± 6	240	2½
BMWG09048BB	MWG PRESSURE VESSEL 9X48 2.5" BLUE	44,4	231	1227 ± 6	240	2½
BMWG10017BB	MWG PRESSURE VESSEL 10X17 2.5" BLUE	16,7	258	445 ± 6	266	2½
BMWG10019BB	MWG PRESSURE VESSEL 10X19 2.5" BLUE	19,3	258	482 ± 6	266	2½
BMWG10024BB	MWG PRESSURE VESSEL 10X24 2.5" BLUE	25,2	258	611 ± 6	266	2½
BMWG10030BB	MWG PRESSURE VESSEL 10X30 2.5" BLUE	33,0	258	780 ± 6	266	2½
BMWG10035BB	MWG PRESSURE VESSEL 10X35 2.5" BLUE	39,4	258	902 ± 6	266	2½
BMWG10044BB	MWG PRESSURE VESSEL 10X44 2.5" BLUE	51,0	258	1132 ± 6	266	2½
BMWG10047BB	MWG PRESSURE VESSEL 10X47 2.5" BLUE	54,1	258	1197 ± 6	266	2½
BMWG10054BB	MWG PRESSURE VESSEL 10X54 2.5" BLUE	63,5	258	1391 ± 6	266	2½
BMWG10054GB	MWG PRESSURE VESSEL 10X54 4" BLUE	63,5	258	1390 ± 6	266	4"
BMWG12048BB	MWG PRESSURE VESSEL 12X48 2.5" BLUE	78,9	308	1234 ± 6	318	2½
BMWG12052BB	MWG PRESSURE VESSEL 12X52 2.5" BLUE	85,9	308	1334 ± 6	318	2½
BMWG13044BB	MWG PRESSURE VESSEL 13X44 2.5" BLUE	83,1	335	1118 ± 6	343	2½
BMWG13054BB	MWG PRESSURE VESSEL 13X54 2.5" BLUE	104,3	335	1375 ± 6	343	2½
BMWG13054GB	MWG PRESSURE VESSEL 13X54 4" BLUE	104,3	335	1375 ± 6	343	4"

Certificates	Manufacturer	Sectors
DM174-2004, ACS, KTW CE, EAC	MWG	Domestic



Structural Residential Pressure Vessels with Base



- Made in European Union (Belgium);
- Composite pressure vessels PE liner reinforced with fiberglass and epoxy resin; For industrial and potable water treatment systems;
- Max operating pressure 10 bar;
- Max operating temperature 50°C;
- Top connection threaded 2 ½" – 8NPSM or 4"– 8UN;
- Cycle test 250.000 times from 0,7 to 10 bar;
- Burst test to 4 times max operating pressure;
- Blue colour;
- Warranty 5 years.

Ref	Description	Fam.	Subfam.	Disp. Stock	
BSQ0613A3	STRUCTURAL PRESSURE VESSEL 6X13 2.5" BLUE	43	432	•	
BSQ0618A3	STRUCTURAL PRESSURE VESSEL 6X18 2.5" BLUE	43	432	•	
BSRT0635P3E	STRUCTURAL PRESSURE VESSEL 6X35 2.5" BLUE	43	432	•	
BSQ0713A3	STRUCTURAL PRESSURE VESSEL 7X13 2.5" BLUE	43	432	•	
BSQ0717A3	STRUCTURAL PRESSURE VESSEL 7X17 2.5" BLUE	43	432	•	
BSRT0724A3E	STRUCTURAL PRESSURE VESSEL 7X24 2.5" BLUE	43	432	•	
BSQ0730A3	STRUCTURAL PRESSURE VESSEL 7X30 2.5" BLUE	43	432	•	
BSQ0735A3	STRUCTURAL PRESSURE VESSEL 7X35 2.5" BLUE	43	432	•	
BSQ0817A3	STRUCTURAL PRESSURE VESSEL 8X17 2.5" BLUE	43	432	•	
BSRT0824A3E	STRUCTURAL PRESSURE VESSEL 8X24 2.5" BLUE	43	432	•	
BSQ0830A3	STRUCTURAL PRESSURE VESSEL 8X30 2.5" BLUE	43	432	•	
BSQ0835A3	STRUCTURAL PRESSURE VESSEL 8X35 2.5" BLUE	43	432		
BSQ0844P3	STRUCTURAL PRESSURE VESSEL 8X44 2.5" BLUE	43	432	•	
BSRT0917A3E	STRUCTURAL PRESSURE VESSEL 9X17 2.5" BLUE	43	432	•	
BSRT0930A3E	STRUCTURAL PRESSURE VESSEL 9X30 2.5" BLUE	43	432	•	
BSQ0935A3	STRUCTURAL PRESSURE VESSEL 9X35 2.5" BLUE	43	432	•	
BSRT0942A3E	STRUCTURAL PRESSURE VESSEL 9X42 2.5" BLUE	43	432	•	
BSRT0948A3E	STRUCTURAL PRESSURE VESSEL 9X48 2.5" BLUE	43	432	•	
BSRT1017A3E	STRUCTURAL PRESSURE VESSEL 10X17 2.5" BLUE	43	432	•	
BSQ1019A3	STRUCTURAL PRESSURE VESSEL 10X19 2.5" BLUE	43	432	•	
BSRT1022A3E	STRUCTURAL PRESSURE VESSEL 10X22 2.5" BLUE	43	432	•	
BSRT1024A3E	STRUCTURAL PRESSURE VESSEL 10X24 2.5" BLUE	43	432	•	
BSRT1030A3E	STRUCTURAL PRESSURE VESSEL 10X30 2.5" BLUE	43	432	•	
BSQ1035A3	STRUCTURAL PRESSURE VESSEL 10X35 2.5" BLUE	43	432	•	
BSQ1044P3	STRUCTURAL PRESSURE VESSEL 10X44 2.5" BLUE	43	432	•	
BSRT1047P3E	STRUCTURAL PRESSURE VESSEL 10X47 2.5" BLUE	43	432	•	
BSQ1054P3	STRUCTURAL PRESSURE VESSEL 10X54 2.5" BLUE	43	432	•	
BSRT1055P3EN	STRUCTURAL PRESSURE VESSEL 10X55 4" BLUE	43	432	•	
BSQ1248P3	STRUCTURAL PRESSURE VESSEL 12X48 2.5" BLUE	43	432	•	
BSQ1252P3	STRUCTURAL PRESSURE VESSEL 12X52 2.5" BLUE	43	432	•	
BSRT1344A3E	STRUCTURAL PRESSURE VESSEL 13X44 2.5" BLUE	43	432	•	
BSQ1354A3	STRUCTURAL PRESSURE VESSEL 13X54 2.5" BLUE	43	432	•	
BSRT1355A3EN	STRUCTURAL PRESSURE VESSEL 13X55 4" BLUE	43	432	•	



Structural Residential Pressure Vessels with Base

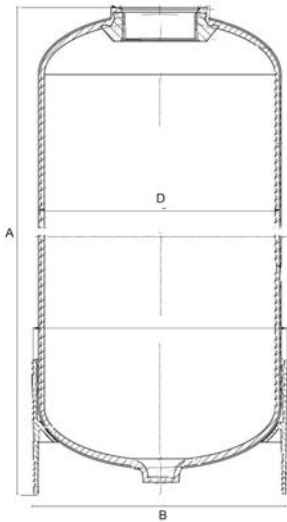

Ref	Volume (liters)	External D (mm)	A (mm)	B (mm)	Connection
BSQ0613A3	4,6	159	342 ± 2	170	2½
BSQ0618A3	6,9	159	475 ± 2	170	2½
BSRT0635P3E	14,4	159	907 ± 2	170	2½
BSQ0713A3	6,3	184	341 ± 2	195	2½
BSQ0717A3	8,8	184	446 ± 2	195	2½
BSRT0724A3E	13,5	184	613 ± 2	195	2½
BSQ0730A3	16,8	184	778 ± 2	195	2½
BSQ0735A3	20,4	184	901 ± 2	195	2½
BSQ0817A3	11,0	208	435 ± 2	220	2½
BSRT0824A3E	16,6	208	612 ± 4	220	2½
BSQ0830A3	22,0	208	783 ± 2	220	2½
BSQ0835A3	25,7	208	902 ± 2	220	2½
BSQ0844P3	33,6	208	1124 ± 2	220	2½
BSRT0917A3E	13,7	233	431 ± 4	240	2½
BSRT0930A3E	26,6	233	766 ± 5	240	2½
BSQ0935A3	31,3	233	903 ± 2	240	2½
BSRT0942A3E	38,2	233	1074 ± 5	240	2½
BSRT0948A3E	44,6	233	1228 ± 5	240	2½
BSRT1017A3E	16,8	257	436 ± 4	269	2½
BSQ1019A3	19,1	257	502 ± 2	269	2½
BSRT1022A3E	22,9	257	559 ± 4	269	2½
BSRT1024A3E	25,1	257	605 ± 4	269	2½
BSRT1030A3E	32,4	257	766 ± 4	269	2½
BSQ1035A3	38,9	257	903 ± 2	269	2½
BSQ1044P3	48	257	1122 ± 2	269	2½
BSRT1047P3E	54	257	1188 ± 5	269	2½
BSQ1054P3	61	257	1385 ± 2	269	2½
BSRT1055P3EN	62	257	1382 ± 5	269	4"
BSQ1248P3	76	304	1232 ± 3	315	2½
BSQ1252P3	84	304	1335 ± 3	315	2½
BSRT1344A3E	85	334	1145 ± 6	330	2½
BSQ1354A3	103	334	1371 ± 3	330	2½
BSRT1355A3EN	103	334	1371 ± 3	330	4"

Certificates	Manufacturer	Sectors
DM174-2004, ACS, KTW, WRAS, CE, EAC	Pentair	Domestic



MWG Residential Pressure Vessels without Base



- Made in China;
- Composite pressure vessels PE liner reinforced with fiberglass and epoxy resin;
- For industrial and potable water treatment systems;
- Max operating temperature 50°C;
- Top connection threaded 2 ½" - 8NPSM or 4"- 8UN;
- Cycle test 250.000 times from 0,7 to 10 bar;
- Burst test to 4 times max operating pressure;
- Blue colour;
- Warranty 10 years.

Ref	Description	Fam.	Subfam.	Disp. Stock	
BMWG05013AB	MWG PRESSURE VESSEL 5X13 2.5" NO BASE BLUE	43	410	•	
BMWG06013AB	MWG PRESSURE VESSEL 6X13 2.5" NO BASE BLUE	43	410	•	
BMWG07013AB	MWG PRESSURE VESSEL 7X13 2.5" NO BASE BLUE	43	410	•	
BMWG07017AB	MWG PRESSURE VESSEL 7X17 2.5" NO BASE BLUE	43	410	•	
BMWG07019AB	MWG PRESSURE VESSEL 7X19 2.5" NO BASE BLUE	43	410	•	
BMWG07024AB	MWG PRESSURE VESSEL 7X24 2.5" NO BASE BLUE	43	410	•	
BMWG07030AB	MWG PRESSURE VESSEL 7X30 2.5" NO BASE BLUE	43	410	•	
BMWG07035AB	MWG PRESSURE VESSEL 7X35 2.5" NO BASE BLUE	43	410	•	
BMWG08013AB	MWG PRESSURE VESSEL 8X13 2.5" NO BASE BLUE	43	410	•	
BMWG08017AB	MWG PRESSURE VESSEL 8X17 2.5" NO BASE BLUE	43	410	•	
BMWG08024AB	MWG PRESSURE VESSEL 8X24 2.5" NO BASE BLUE	43	410	•	
BMWG08030AB	MWG PRESSURE VESSEL 8X30 2.5" NO BASE BLUE	43	410	•	
BMWG08035AB	MWG PRESSURE VESSEL 8X35 2.5" NO BASE BLUE	43	410	•	
BMWG09017AB	MWG PRESSURE VESSEL 9X17 2.5" NO BASE BLUE	43	410	•	
BMWG09024AB	MWG PRESSURE VESSEL 9X24 2.5" NO BASE BLUE	43	410	•	
BMWG09030AB	MWG PRESSURE VESSEL 9X30 2.5" NO BASE BLUE	43	410	•	
BMWG09035AB	MWG PRESSURE VESSEL 9X35 2.5" NO BASE BLUE	43	410	•	
BMWG10017AB	MWG PRESSURE VESSEL 10X17 2.5" NO BASE BLUE	43	410	•	
BMWG10019AB	MWG PRESSURE VESSEL 10X19 2.5" NO BASE BLUE	43	410	•	
BMWG10024AB	MWG PRESSURE VESSEL 10X24 2.5" NO BASE BLUE	43	410	•	
BMWG10030AB	MWG PRESSURE VESSEL 10X30 2.5" NO BASE BLUE	43	410	•	
BMWG10035AB	MWG PRESSURE VESSEL 10X35 2.5" NO BASE BLUE	43	410	•	



MWG Residential Pressure Vessels without Base

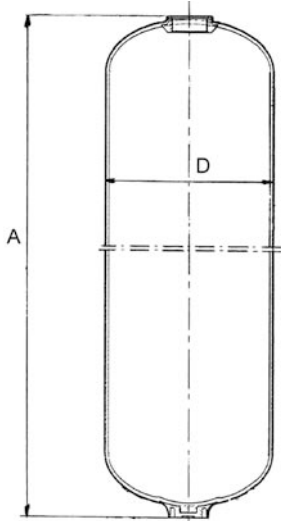

Ref	Volume (liters)	External D (mm)	A (mm)	Connection (inch)
BMWG05013AB	3,1	129	329 ± 3	2½
BMWG06013AB	4,7	159,5	329 ± 3	2½
BMWG07013AB	5,9	180	329 ± 3	2½
BMWG07017AB	8,2	180	431 ± 3	2½
BMWG07019AB	9,4	180	483 ± 3	2½
BMWG07024AB	12,4	180	611 ± 3	2½
BMWG07030AB	16,01	180	771 ± 3	2½
BMWG07035AB	18,09	180	891 ± 3	2½
BMWG08013AB	7,6	207	329 ± 3	2½
BMWG08017AB	10,07	207	431 ± 3	2½
BMWG08024AB	16,03	207	611 ± 3	2½
BMWG08030AB	21,2	207	771 ± 3	2½
BMWG08035AB	25,0	207	891 ± 3	2½
BMWG09017AB	13,3	230	431 ± 3	2½
BMWG09024AB	20,3	230	611 ± 3	2½
BMWG09030AB	26,5	230	771 ± 3	2½
BMWG09035AB	31,1	230	891 ± 3	2½
BMWG10017AB	16,4	257,5	431 ± 3	2½
BMWG10019AB	19,0	257,5	483 ± 3	2½
BMWG10024AB	25,2	257,5	611 ± 3	2½
BMWG10030AB	33,0	257,5	771 ± 3	2½
BMWG10035AB	38,8	257,5	891 ± 3	2½

Certificates	Manufacturer	Sectors
DM174-2004 ACS KTW CE, EAC	MWG	Domestic



Structural Dome-Hole Residential Pressure Vessels



- Made in U.S.A.;
- Composite pressure vessels PE liner reinforced with fiberglass and epoxy resin;
- 1 1/4" opening on the dome top of the tank with Noryl plug;
- For industrial and potable water treatment systems;
- European 2014/68/EU Directive compliant for pressure equipment (PED);
- Max operating pressure 10 bar;
- Max operating temperature 50°C;
- Top connection threaded 2 1/2" – 8NPSM;
- Cycle test 250.000 times from 0,7 to 10 bar;
- Burst test to 4 times max operating pressure;
- Natural colour;
- Warranty 5 years.

Ref	Description	Fam.	Subfam.	Disp. Stock	
B10044QN	PRESSURE VESSEL 10X44 DOME HOLE 2.5" NATURAL	43	450		
B10054QN	PRESSURE VESSEL 10x54 DOME HOLE 2.5" NATURAL	43	450		
B12052QN	PRESSURE VESSEL 12X52 DOME HOLE 2.5" NATURAL	43	450		
B13054QN	PRESSURE VESSEL 13X54 DOME HOLE 2.5" NATURAL	43	450		

Ref	Volume (Liters)	D External (mm)	A (mm)	B (mm)	Connection (pollici)
B10044QN	48	257	1122	269	2½
B10054QN	61	257	1378	269	2½
B12052QN	84	306	1346	312	2½
B13054QN	103	364	1370	375	2½

Certificates	Manufacturer	Sectors
CE	Pentair	Commercial, Industrial

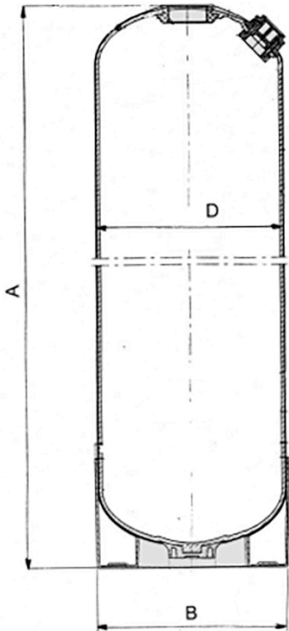



MWG Industrial Pressure Vessels With Threaded Top Opening

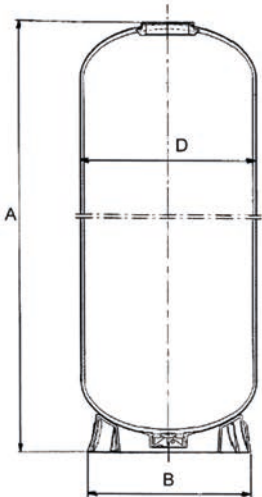

- Made in China; Composite pressure vessels PE liner reinforced with fiberglass and epoxy resin;
- For industrial and potable water treatment systems;
- European 2014/68/EU Directive compliant for pressure equipment (PED);
- Max operating pressure 10 bar; Max operating temperature 50°C; Burst test to 4 times max operating pressure; Warranty 5 Yrs;
- Pressure vessels 16" and less are shipped with reduction 2,5";
- Pressure vessels 30" and greater are shipped with vacuum breaker.

Ref	Description	Fam.	Subfam.	Disp. Stock	
BMWG14052GB	MWG PRESSURE VESSEL 14X52 4" BLUE WITH ADAPTER 2.5"	44	420	•	
BMWG14065GB	MWG PRESSURE VESSEL 14X65 4" BLUE WITH ADAPTER 2.5"	44	420	•	
BMWG16052GB	MWG PRESSURE VESSEL 16X52 4" BLUE WITH ADAPTER 2.5"	44	420	•	
BMWG16065GB	MWG PRESSURE VESSEL 16X65 4" BLUE WITH ADAPTER 2.5"	44	420	•	
BMWG18053GB	MWG PRESSURE VESSEL 18X53 4" BLUE	44	420	•	
BMWG18065GB	MWG PRESSURE VESSEL 18X65 4" BLUE	44	420	•	
BMWG21036GB	MWG PRESSURE VESSEL 21X36 4" BLUE	44	420	•	
BMWG21053GB	MWG PRESSURE VESSEL 21X53 4" BLUE	44	420	•	
BMWG21062GB	MWG PRESSURE VESSEL 21X62 4" BLUE	44	420	•	
BMWG24065GB	MWG PRESSURE VESSEL 24X65 4" BLUE	44	420	•	
BMWG24072GB	MWG PRESSURE VESSEL 24X72 4" BLUE	44	420	•	
BMWG30072GB	MWG PRESSURE VESSEL 30X72 4" BLUE	44	420	•	
BMWG36072GB	MWG PRESSURE VESSEL 36X72 4" BLUE	44	420	•	

Ref	Volume (Liters)	External D (mm)	A (mm)	B (mm)	Connection (Inch)
BMWG14052GB	115,4	360	1325 ± 6	369	4"
BMWG14065GB	147,0	360	1655 ± 6	369	4"
BMWG16052GB	150,0	410	1316 ± 6	420	4"
BMWG16065GB	191,3	410	1648 ± 6	420	4"
BMWG18053GB	193,6	464	1366 ± 6	451	4"
BMWG18065GB	242,3	464	1670 ± 6	451	4"
BMWG21036GB	168,2	541	958 ± 10	532	4"
BMWG21053GB	262,4	541	1390 ± 10	532	4"
BMWG21062GB	312,7	541	1620 ± 10	532	4"
BMWG24065GB	426,5	615	1730 ± 10	612	4"
BMWG24072GB	477,5	615	1910 ± 10	612	4"
BMWG30072GB	725,9	767	1890 ± 10	752	4"
BMWG36072GB	1030	919	1965 ± 10	910	4"

Certificates	Manufacturer	Sectors
DM174-2004 ACS KTW CE, EAC	MWG	Commercial, Industrial



Structural Industrial Pressure Vessels With Threaded Top Opening

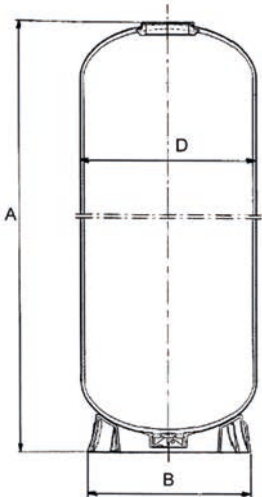

- Made in European Union (Belgium); composite pressure vessels PE liner reinforced with fiberglass and epoxy resin; for industrial and potable water treatment systems;
- European 2014/68/EU Directive compliant for pressure equipment (PED);
- Max operating pressure 10 bar; Max operating temperature 50°C;
- Threaded top connection 4" - 8UN;
- Cycle test 250.000 times from 0,7 to 10 bar; burst test to 4 times max operating pressure; Warranty 5 years;
- Pressure vessels 16" and less are shipped with reduction 2,5";
- Pressure vessels 30" and greater are shipped with vacuum breaker.

Ref	Description	Fam.	Subfam.	Disp. Stock	
BSRT1452A3REN	STRUCTURAL PRESSURE VESSEL 14X52 4" BLUE WITH ADAPTER 2.5"	44	440	•	
BSRT1465A3REN	STRUCTURAL PRESSURE VESSEL 14X65 4" BLUE WITH ADAPTER 2.5"	44	440	•	
BSRT1649A3REN	STRUCTURAL PRESSURE VESSEL 16X49 4" BLUE WITH ADAPTER 2.5"	44	440	•	
BSRT1665A3REN	STRUCTURAL PRESSURE VESSEL 16X65 4" BLUE WITH ADAPTER 2.5"	44	440	•	
BSRT1856A3E	STRUCTURAL PRESSURE VESSEL 18X56 4" BLUE	44	440	•	
BSRT1865A3EN	STRUCTURAL PRESSURE VESSEL 18X65 4" BLUE	44	440	•	
BSRT2153A3E	STRUCTURAL PRESSURE VESSEL 21X53 4" BLUE	44	440	•	
BSRT2160A3E	STRUCTURAL PRESSURE VESSEL 21X60 4" BLUE	44	440	•	
BSRT2469A3E	STRUCTURAL PRESSURE VESSEL 24X69 4" BLUE	44	440	•	
BSRT3072A3E	STRUCTURAL PRESSURE VESSEL 30X72 4" BLUE	44	440	•	
BSRT3672A3E	STRUCTURAL PRESSURE VESSEL 36X72 4" BLUE	44	440	•	

Ref	Volume (liters)	External D (mm)	A (mm)	B (mm)	Connection (Inch)
BSRT1452A3REN	122	369	1360 ± 20	330	4"
BSRT1465A3REN	140	369	1645 ± 20	380	4"
BSRT1649A3REN	125	406	1269 ± 20	420	4"
BSRT1665A3REN	170	406	1632 ± 20	420	4"
BSRT1856A3E	211	469	1432 ± 20	510	4"
BSRT1865A3EN	250	469	1726 ± 20	510	4"
BSRT2153A3E	277	552	1434 ± 20	510	4"
BSRT2160A3E	310	552	1625 ± 20	510	4"
BSRT2469A3E	440	610	1870 ± 20	510	4"
BSRT3072A3E	710	770	2030 ± 30	730	4"
BSRT3672A3E	1020	930	2130 ± 30	730	4"

Certificates	Manufacturer	Sectors
DM174-2004 ACS KTW WRAS CE, EAC	Pentair	Commercial, Industrial



MWG Industrial Pressure Vessels With Top&Bottom Threaded Openings

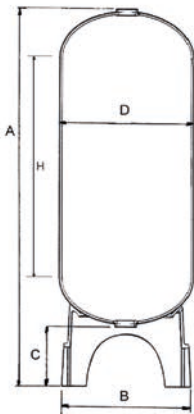

- Made in China;
- Composite pressure vessels PE liner reinforced with fiberglass and epoxy resin;
- For industrial and potable water treatment systems;
- European 2014/68/EU Directive compliant for pressure equipment (PED);
- Max operating pressure 10 bar;
- Max operating temperature 50°C;
- Top and bottom threaded connection 4"- 8UN; Cycle test 250.000 times from 0,7 to 10 bar;
- Burst test to 4 times max operating pressure;
- Blue colour;
- Warranty 5 years;
- Pressure vessels 30" and greater are shipped with vacuum breaker.

Ref	Description	Fam.	Subfam.	Disp. Stock	
BMWG14065HB	MWG PRESSURE VESSEL 14X65 4" + 4" BLUE	44	420	•	
BMWG16065HB	MWG PRESSURE VESSEL 16X65 4" + 4" BLUE	44	420	•	
BMWG18065HB	MWG PRESSURE VESSEL 18X65 4" + 4" BLUE	44	420	•	
BMWG21062HB	MWG PRESSURE VESSEL 21X62 4" + 4" BLUE	44	420	•	
BMWG24065HB	MWG PRESSURE VESSEL 24X65 4" + 4" BLUE	44	420	•	
BMWG24072HB	MWG PRESSURE VESSEL 24X72 4" + 4" BLUE	44	420	•	
BMWG30072HB	MWG PRESSURE VESSEL 30X72 4" + 4" BLUE	44	420	•	
BMWG36072HB	MWG PRESSURE VESSEL 36X72 4" + 4" BLUE	44	420	•	

Ref	Volume (Liters)	External D (mm)	A (mm)	B (mm)	C (mm)	H (mm)	Connection (Inch)
BMWG14065HB	147,0	360	1856 ±6	369	230	1386	4"
BMWG16065HB	191,3	410	188 ± 6	430	250	1365	4"
BMWG18065HB	242,3	464	1950 ± 01	480	320	1330	4"
BMWG21062HB	312,7	541	1902 ± 01	555	330	1220	4"
BMWG24065HB	426,5	615	1916 ± 01	610	246	1220	4"
BMWG24072HB	477,5	615	2095 ± 01	610	240	1400	4"
BMWG30072HB	726	750	2075 ± 01	762	235	1270	4"
BMWG36072HB	1030,2	922	2190 ± 01	930	350	1170	4"

Certificates	Manufacturer	Sectors
DM174-2004 ACS KTW CE, EAC	MWG	Commercial, Industrial



Structural Industrial Pressure Vessels With Top&Bottom Threaded Openings



- Made in European Union (Belgium);
- Composite pressure vessels PE liner reinforced with fiberglass and epoxy resin;
- For industrial and potable water treatment systems;
- European 2014/68/EU Directive compliant for pressure equipment (PED);
- Max operating pressure 10 bar;
- Max operating temperature 50°C;
- Top and bottom threaded connection 4"- 8UN;
- Cycle test 250.000 times from 0,7 to 10 bar;
- Burst test to 4 times max operating pressure;
- Blue colour;
- Warranty 5 years;
- Pressure vessels 30" and greater are shipped with vacuum breaker.

Ref	Description	Fam.	Subfam.	Disp. Stock	
BSRT1465F7E	STRUCTURAL PRESSURE VESSEL 14X65 4" + 4" BLUE	44	440	•	
BSRT1665F7E	STRUCTURAL PRESSURE VESSEL 16X65 4" + 4" BLUE	44	440	•	
BSRT1865F7E	STRUCTURAL PRESSURE VESSEL 18X65 4" + 4" BLUE	44	440	•	
BSRT2160F7E	STRUCTURAL PRESSURE VESSEL 21X60 4" + 4" BLUE	44	440	•	
BSRT2469F7E	STRUCTURAL PRESSURE VESSEL 24X69 4" + 4" BLUE	44	440	•	
BSRT3072F7E	STRUCTURAL PRESSURE VESSEL 30X72 4" + 4" BLUE	44	440	•	
BSRT3672F7E	STRUCTURAL PRESSURE VESSEL 36X72 4" + 4" BLUE	44	440	•	

Ref	Volume (liters)	External D (mm)	A (mm)	B (mm)	C (mm)	H (mm)	Connection (Inch)
BSRT1465F7E	140	369	2031 ± 20	488	381	1378	4"
BSRT1665F7E	170	406	2031 ± 20	497	384	1371	4"
BSRT1865F7E	250	469	2080 ± 20	554	404	1350	4"
BSRT2160F7E	310	552	1923 ± 20	554	389	1155	4"
BSRT2469F7E	440	610	2169 ± 20	620	422	1327	4"
BSRT3072F7E	710	770	2248 ± 30	816	413	1313	4"
BSRT3672F7E	1020	927	2305 ± 30	1001	408	1266	4"

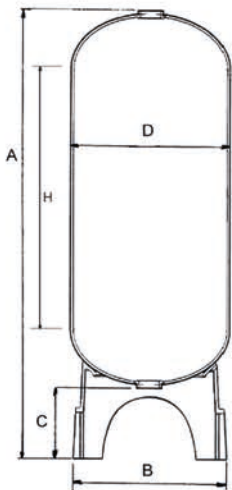

Certificates	Manufacturer	Sectors
DM174-2004 ACS KTW WRAS CE, EAC	Pentair	Commercial, Industrial



Structural Industrial Pressure Vessels With Flanged Top Opening



- Made in European Union (Belgium);
- Composite pressure vessels PE liner reinforced with fiberglass and epoxy resin;
- For industrial and potable water treatment systems;
- European 2014/68/EU Directive compliant for pressure equipment (PED);
- Max operating pressure 10 bar;
- Max operating temperature 65°C;
- 6" top connection;
- Cycle test 250.000 times from 0,7 to 10 bar;
- Burst test to 4 times max operating pressure;
- Blue colour;
- Warranty 5 years;
- Pressure vessels 30" and greater are shipped with vacuum breaker.

Ref	Description	Fam.	Subfam.	Disp. Stock	
BSRT1868A3E	STRUCTURAL PRESSURE VESSEL 18X68 6" BLUE	44	442	•	
BSRT2166A3E	STRUCTURAL PRESSURE VESSEL 21X66 6" BLUE	44	442	•	
BSRT2475A3E	STRUCTURAL PRESSURE VESSEL 24X75 6" BLUE	44	442	•	
BSRT3078A3E	STRUCTURAL PRESSURE VESSEL 30X78 6" BLUE	44	442	•	
BSRT3678A3E	STRUCTURAL PRESSURE VESSEL 36X78 6" BLUE	44	442	•	

Ref	Volume (Liters)	External D (mm)	A (mm)	B (mm)	H (mm)	Connection (Inch)
BSRT1868A3E	250	469	1777 ± 20	510	1344	6"
BSRT2166A3E	310	552	1673 ± 20	510	1159	6"
BSRT2475A3E	450	610	1908 ± 20	510	1320	6"
BSRT3078A3E	710	770	2058 ± 30	768	1282	6"
BSRT3678A3E	1020	927	2155 ± 30	768	1235	6"

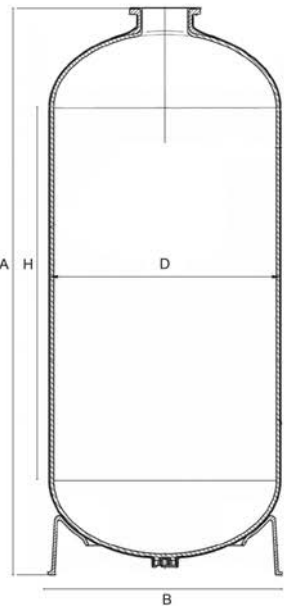

Certificates	Manufacturer	Sectors
DM174-2004 ACS KTW WRAS CE, EAC	Pentair	Industrial



MWG Industrial Pressure Vessels With Flanged Top&Bottom Openings

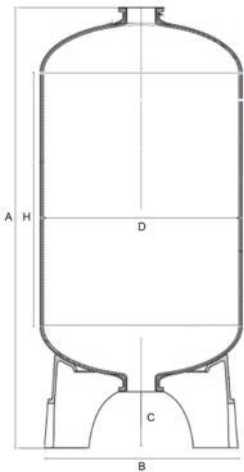

- Made in China;
- Composite pressure vessels PE liner reinforced with fiberglass and epoxy resin;
- For industrial and potable water treatment systems;
- European 2014/68/EU Directive compliant for pressure equipment (PED);
- Max operating pressure 10 bar;
- Max operating temperature 65°C;
- Top and bottom 6" flange connection;
- Cycle test 250.000 times from 0,7 to 10 bar;
- Burst test to 4 times max operating pressure; Blue colour;
- Warranty 5 years;
- Pressure vessels 30" and greater are shipped with vacuum breaker;
- For 63" pressure vessels, when you use a DN100 lower system, you have to raise the pressure vessel.

Ref	Description	Fam.	Subfam.	Disp. Stock	
BMWG30072MB	MWG PRESSURE VESSEL 30X72 6" + 6" BLUE	44	422	•	
BMWG36072MB	MWG PRESSURE VESSEL 36X72 6" + 6" BLUE	44	422	•	
BMWG42063MB	MWG PRESSURE VESSEL 42X63 6"+6" BLUE	43	422	•	
BMWG42072MB	MWG PRESSURE VESSEL 42X72 6" + 6" BLUE	44	422	•	
BMWG48072MB	MWG PRESSURE VESSEL 48X72 6" + 6" BLUE	44	422	•	
BMWG63067MB	MWG PRESSURE VESSEL 63X67 6" + 6" BLUE	44	422	•	
BMWG63086MB	MWG PRESSURE VESSEL 63X86 6" + 6" BLUE	44	422	•	

Ref	Volume (litres)	External D (mm)	A (mm)	B (mm)	C (mm)	H (mm)	Connection (inch)
BMWG30072MB	736	772	2245 ± 25	815	265	1260	6"
BMWG36072MB	1045	925	2270 ± 25	920	285	1195	6"
BMWG42063MB	1235	1085	2055 ± 25	1070	270	955	6"
BMWG42072MB	1437	1085	2290 ± 25	1070	275	1185	6"
BMWG48072MB	1784	1218	2275 ± 25	1230	260	1110	6"
BMWG63067MB	2630	1608	2050 ± 25	1620	260	660	6"
BMWG63086MB	3425	1608	2460 ± 25	1620	260	1100	6"

Certificates	Manufacturer	Sectors
DM174-2004 ACS KTW CE, EAC	MWG	Industrial



Structural Industrial Pressure Vessels With Flanged Top&Bottom Openings

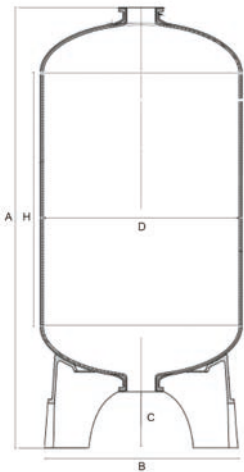

- Made in European Union (Belgium);
- Composite pressure vessels PE liner reinforced with fiberglass and epoxy resin;
- For industrial and potable water treatment systems;
- European 2014/68/EU Directive compliant for pressure equipment (PED);
- Max operating pressure 10 bar;
- Max operating temperature 65°C;
- Top and bottom 6" flange connection;
- Cycle test 250.000 times from 0,7 to 10 bar;
- Burst test to 4 times max operating pressure;
- Blue colour; Warranty 5 years;
- Pressure vessels 30" and greater are shipped with vacuum breaker.

Ref	Description	Fam.	Subfam.	Disp. Stock	
BSC1868F7	STRUCTURAL PRESSURE VESSEL 18X68 6" + 6" BLUE	44	442	•	
BSC2166F7	STRUCTURAL PRESSURE VESSEL 21X66 6" + 6" BLUE	44	442	•	
BSC2475F7	STRUCTURAL PRESSURE VESSEL 24X75 6" + 6" BLUE	44	442	•	
BSC3078F7	STRUCTURAL PRESSURE VESSEL 30X78 6" + 6" BLUE	44	442	•	
BSC3678F7	STRUCTURAL PRESSURE VESSEL 36X78 6" + 6" BLUE	44	442	•	
BSRT4264F7E	STRUCTURAL PRESSURE VESSEL 42X64 6" + 6" BLUE	44	442	•	
BSC4278F7	STRUCTURAL PRESSURE VESSEL 42X78 6" + 6" BLUE	44	442	•	
BSC4882F7	STRUCTURAL PRESSURE VESSEL 48X82 6" + 6" BLUE	44	442	•	
BSC55104F7	STRUCTURAL PRESSURE VESSEL 55X104 6" + 6" BLUE	44	442		
BSC55120F7	STRUCTURAL PRESSURE VESSEL 55X120 6" + 6" BLUE	44	442		
BSC55130F7	STRUCTURAL PRESSURE VESSEL 55X130 6" + 6" BLUE	44	442		
BSC55140F7	STRUCTURAL PRESSURE VESSEL 55X140 6" + 6" BLUE	44	442		
BSRT6367F7E	STRUCTURAL PRESSURE VESSEL 63X67 6" + 6" BLUE	44	442	•	
BSRT6386F7E	STRUCTURAL PRESSURE VESSEL 63X86 6" + 6" BLUE	44	442	•	
BSC63103F7	STRUCTURAL PRESSURE VESSEL 63X103 6" + 6" BLUE	44	442		
BSC63113F7	STRUCTURAL PRESSURE VESSEL 63X113 6" + 6" BLUE	44	442		
BSC63123F7	STRUCTURAL PRESSURE VESSEL 63X123 6" + 6" BLUE	44	442		

Ref	Volume (litres)	External D (mm)	A (mm)	B (mm)	C (mm)	H (mm)	Connection (Inch)
BSC1868F7	250	469	2120 ± 20	545	340	1344	6"
BSC2166F7	310	552	2010 ± 20	545	368	1158	6"
BSC2475F7	450	610	2220 ± 20	620	354	1320	6"
BSC3078F7	710	770	2285 ± 30	778	365	1284	6"
BSC3678F7	1020	927	2330 ± 30	955	355	1272	6"
BSRT4264F7E	1047	1074	2065 ± 30	1110	440	775	6"
BSC4278F7	1360	1074	2402 ± 30	1110	395	1162	6"
BSC4882F7	1840	1226	2442 ± 30	1270	387	1075	6"
BSC55104F7	2619	1429	2661 ± 30	1370	539	1106	6"
BSC55120F7	3220	1429	3061 ± 30	1370	545	1500	6"
BSC55130F7	3602	1429	3311 ± 30	1370	545	1750	6"
BSC55140F7	3984	1429	3561 ± 30	1370	545	2000	6"
BSRT6367F7E	2484	1623	2075 ± 30	1570	355	594	6"
BSRT6386F7E	3200	1623	2475 ± 30	1570	355	996	6"
BSC63103F7	4265	1623	3250 ± 30	1570	627	1500	6"
BSC63113F7	4760	1623	3500 ± 30	1570	627	1750	6"
BSC63123F7	5255	1623	3750 ± 30	1570	627	2000	6"

Certificates	Manufacturer	Sectors
DM174-2004 ACS KTW WRAS CE, EAC	Pentair	Industrial



Pressure Vessels Accessories

Adapters



- adapter 4"- 8UN to 2 1/2" - 8NPSM;
- with O-ring.

Ref	Description	Fam.	Subfa m.	Disp. Stock	
PV300	ADAPTER 4"x2.1/2"NPSM W/O-RING	45	201	•	
PV307	PVC ADAPTER 4"-8UN X 2" BSP	45	201	•	

Ref	Description	Material	Reduction to
PV300	ADAPTER 4"x2.1/2"NPSM W/O-RING	PVC machined	2 1/2" - 8 NPSM
PV307	PVC ADAPTER 4"-8UN X 2" BSP	PVC machined	2" BSP



Closures

- closure for 4"- 8UN tanks thread;
- with O-ring.

Ref	Description	Fam.	Subfa m.	Disp. Stock	
PV301	CLOSURE 4"-8UN W/ O-RING	45	201	•	

Ref	Description	Material
PV301	CLOSURE 4"-8UN W/ O-RING	PVC machined

6" closed flange



- Closed flange complete with bolts, nuts, washer and O-ring;
- Flange material PVC;
- Bolts material AISI 304.

Ref	Description	Fam.	Subfa m.	Disp. Stock	
PV510B	6" PVC FLANGED CLOSURE W/ O-RING AND SCREWS*	45	201	•	

6" - 4" adapter



- 6" flanged adapter 4"-8UN, complete with bolts, nuts, washer and O-ring;
- Bolts material AISI 304.

Ref	Description	Fam.	Subfa m.	Disp. Stock	
PV511B	FLANGED ADAPTER 6"-4" 8UN W/ O-RING AND SCREWS*	45	201	•	

Ref	Description	Adapter material
PV511B	FLANGED ADAPTER 6"-4" 8UN W/ O-RING AND SCREWS*	PVC



Pressure Vessels Accessories

6" - 3" - 3" adapter

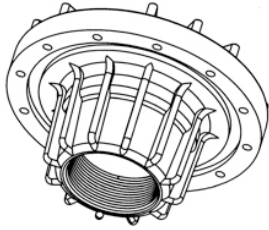

- 6" flanged x 3" x 3" BSP threaded adapter complete with bolts, nuts, washer and O-ring.;
- Flange material PPO;
- Bolts material AISI 304.

Ref	Description	Fam.	Subfam.	Disp. Stock	
PV509	FLANGED ADAPTER 6" - 3" - 3" BSPP W/ O-RING AND SCREWS	45	201		

Certificates	Manufacturer	Sectors
		Industrial

Aeration valve & vacuum breaker

- Aeration valve and vacuum breaker in PP;
- Connection 1 1/2", drain 1/2";
- Max pressure 10 bar;
- Max temperature 65°C.

Ref	Description	Fam.	Subfam.	Disp. Stock	
PV308	AERATION VALVE AND VACUUM BREAKER 1"1/2	45	201	•	
PV308B	MWG AERATION VALVE AND VACUUM BREAKER 1"	45	201	•	

Cylindrical diffusors

- Cylindrical diffusor for vessels with 4"- 8UN, for upper or lower installation;
- Outlet connection to glue D.63;
- 0,2 mm slots or 0,5 mm;
- Materials: adapter PVC, diffusor PP;
- Flow 20 m3/h at Δp 0,2 bar;
- A. union D63 (REF. PV329);
- B. adapter 4" with gasket (REF. PV332);
- C. reduction 2" M/F (REF. PV335);
- D. diffusor diameter 85 mm length 180 mm.(REF. PV340 0,2 mm slots - REF. PV342 0,5 mm slots).

Ref	Description	Fam.	Subfam.	Disp. Stock	
PV351	TOP/BOTTOM CYLINDRICAL DISTRIBUTOR 4"-8UN D.63 PIPE UNION DIFF. 0,2 MM*	45	201	•	
PV352	TOP/BOTTOM CYLINDRICAL DISTRIBUTOR 4"-8UN D.63 PIPE UNION DIFF. 0,5 MM*	45	201	•	

Ref	Description	Fessure (mm)	Ø Bomoie abbinabili
PV351	TOP/BOTTOM CYLINDRICAL DISTRIBUTOR 4"-8UN D.63 PIPE UNION DIFF. 0,2 MM*	0,2	14" ÷ 36"
PV352	TOP/BOTTOM CYLINDRICAL DISTRIBUTOR 4"-8UN D.63 PIPE UNION DIFF. 0,5 MM*	0,5	14" ÷ 36"

Certificates	Manufacturer	Sectors
		Industrial

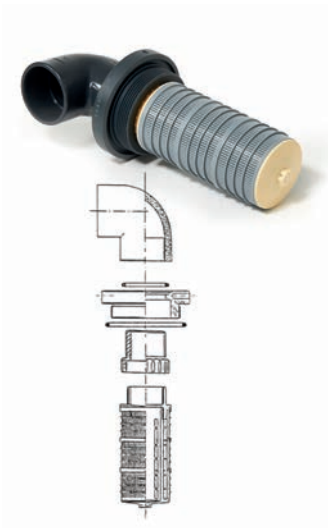

Cylindrical diffusers with elbow

- Cylindrical diffuser for vessel 4"-8UN, for upper installation;
- Outlet connection with elbow to glue D63;
- 0,2 mm slots or 0,5 mm
- Materials: adapter and elbow PVC, diffuser PP;
- Flow 20 m³/h at Δp 0,2 bar;
- Including:
 - A. elbow D63 (REF. PV331);
 - B. adapter 4" with gasket (REF. PV332);
 - C. reduction 2" M/F (REF. PV335);
 - D. diffuser con diameter 85 mm length 180 mm (REF.PV340 0,2 mm slots - REF.PV342 0,5 mm slots).

Ref	Description	Fam.	Subfam.	Disp. Stock	
PV350	TOP CYLINDRICAL DISTRIBUTOR 4"-8UN X DN63 ELBOW DIFF. 0,2MM*	45	201	•	
PV349	TOP CYLINDRICAL DISTRIBUTOR 4"-8UN X DN63 ELBOW DIFF. 0,5MM*	45	201	•	

Ref	Description	Slots (mm)	Ø Vessel
PV350	TOP CYLINDRICAL DISTRIBUTOR 4"-8UN X DN63 ELBOW DIFF. 0,2MM*	0,2	14" ÷ 36"
PV349	TOP CYLINDRICAL DISTRIBUTOR 4"-8UN X DN63 ELBOW DIFF. 0,5MM*	0,5	14" ÷ 36"

Certificates	Manufacturer	Sectors
		Industrial

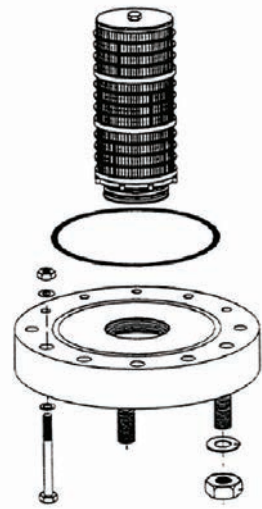

Flanged upper diffusers

- Upper diffuser 6" flanged, complete with bolts, nuts, washer and O-ring;
- Flange material PVC;
- PP cylindrical diffuser 0,2 mm slots or 0,5 mm slots;
- Bolts material AISI 304.

Ref	Description	Fam.	Subfam.	Disp. Stock	
PV512	TOP CYLINDRICAL DISTRIBUTOR FLANGED 6" X DN65 DIFF. 0,2MM*	45	201	•	
PV514	TOP CYLINDRICAL DISTRIBUTOR FLANGED 6" X DN80 DIFF. 0,2MM*	45	201	•	
PV515	TOP CYLINDRICAL DISTRIBUTOR FLANGED 6" X DN80 DIFF. 0,2 MM - 312 MM*	45	201	•	
PV553	CYLINDRICAL DISTRIBUTOR FLANGED 6" DN 80 DIFF. 0,2 MM - 384 MM *	45	201	•	
PV518	TOP CYLINDRICAL DISTRIBUTOR FLANGED 6" DN100 DIFF 0,2 MM - 384 MM*	45	201	•	
PV513	TOP CYLINDRICAL DISTRIBUTOR FLANGED 6" X DN65 DIFF. 0,5MM*	45	201	•	
PV516	TOP CYLINDRICAL DISTRIBUTOR FLANGED 6" DN80 DIFF 0,5 MM - 240 MM*	45	201	•	
PV517	TOP CYLINDRICAL DISTRIBUTOR FLANGED 6" DN80 DIFF 0,5 MM - 312 MM*	45	201	•	
PV554	CYLINDRICAL DISTRIBUTOR FLANGED 6" DN 80 DIFF. 0,5 MM - 384 MM *	45	201	•	
PV519	TOP CYLINDRICAL DISTRIBUTOR FLANGED 6" DN100 DIFF 0,5 MM - 384 MM*	45	201	•	

Ref	Ø VESSEL	Ø Cylindrical diffuser (mm)	Cylindrical diffuser Length (mm)	Slots (mm)	Flow (m³/h) Δp 0,2 bar
PV512	18" ÷ 36"	85	284	0,2	20
PV514	24" ÷ 36"	120	240	0,2	30
PV515	42" ÷ 48"	120	312	0,2	36
PV553	63"	120	384	0,2	50
PV518	63"	120	384	0,2	60
PV513	18" ÷ 36"	85	284	0,5	20
PV516	24" ÷ 36"	120	240	0,5	30
PV517	42" ÷ 48"	120	312	0,5	36
PV554	63"	120	384	0,5	50
PV519	63"	120	384	0,5	60

Certificates	Manufacturer	Sectors
		Industrial



Pressure Vessels Accessories

Cylindrical diffusers

- PP cylindrical diffuser with thread connection 2", 3" or 4";
- Slots 0,2 or 0,5 mm.



Ref	Description	Fam.	Subfam.	Disp. Stock	
PV340	CYLINDRICAL DIFFUSER 2" L=180-0.2 MM	45	201	•	
PV339	CYLINDRICAL DIFFUSER 2" L=284 - 0,2MM	45	201	•	
PV341	CYLINDRICAL DIFFUSER 2" L=338 - 0,2MM	45	201	•	
PV342	CYLINDRICAL DIFFUSER 2" L=180 - 0,5MM	45	201	•	
PV343	CYLINDRICAL DIFFUSER 2" L=284 - 0,5MM	45	201	•	
PV344	CYLINDRICAL DIFFUSER 2" L=338 - 0,5MM	45	201	•	
PV364	CYLINDRICAL DIFFUSER 3" L=240 - 0,2MM	45	201	•	
PV365	CYLINDRICAL DIFFUSER 3" L=312 - 0,2 MM	45	201	•	
PV366	CYLINDRICAL DIFFUSER 3" L=384 - 0,2 MM	45	201	•	
PV367	CYLINDRICAL DIFFUSER 3" L=240 - 0,5 MM	45	201	•	
PV368	CYLINDRICAL DIFFUSER 3" L=312 - 0,5 MM	45	201	•	
PV369	CYLINDRICAL DIFFUSER 3" L=384 - 0,5 MM	45	201	•	
PV393	CYLINDRICAL DIFFUSER 4" 8UN L=384 - 0,2 MM	45	201	•	
PV394	CYLINDRICAL DIFFUSER 4" 8UN L=384 - 0,5 MM	45	201	•	

Ref	Connection	Ø Diameter(mm)	Lenght(mm)	Slots (mm)
PV340	2"	85	180	0,2
PV339	2"	85	284	0,2
PV341	2"	85	338	0,2
PV342	2"	85	180	0,5
PV343	2"	85	284	0,5
PV344	2"	85	338	0,5
PV364	3"	120	240	0,2
PV365	3"	120	312	0,2
PV366	3"	120	384	0,2
PV367	3"	120	240	0,5
PV368	3"	120	312	0,5
PV369	3"	120	384	0,5
PV393	4"	120	384	0,2
PV394	4"	120	384	0,5

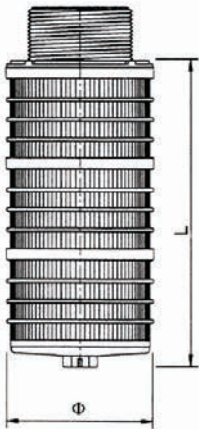

Certificates	Manufacturer	Sectors
		Industrial



Lower lateral system

- Lower lateral system for vessels with 4" - 8UN opening;
- Outlet connection to glue D63;
- Slots 0,2 or 0,5 mm;
- Materials: adapter PVC, hub and laterals PP;
- Including:
 - A. union D63 (REF. PV329);
 - B. adapter 4" with O-rings (REF. PV332);
 - C. reduction 2" M/F (REF. PV335);
 - D. n.3 spacers (REF. PV337);
 - E. hub (REF. PV336);
 - F. N.5 laterals diameter 54 mm, length = see table.

Ref	Description	Fam.	Subfam.	Disp. Stock	
PV353	LOWER LATERAL SYSTEM 4"-8UN X D.63 PRES.VES. 14"-16"-18" SLOTS 0,2 MM*	45	201	•	
PV354	LOWER LATERAL SYSTEM 4"-8UN X D.63 PRES.VES.21"-24" SLOTS 0,2 MM*	45	201	•	
PV355	LOWER LATERAL SYSTEM 4"-8UN X D.63 PRES.VES.30" SLOTS 0,2 MM*	45	201	•	
PV356	LOWER LATERAL SYSTEM 4"-8UN X D.63 PRES.VES.36" SLOTS 0,2 MM*	45	201	•	
PV360	LOWER LATERAL SYSTEM 4"-8UN X D.63 PRES.VES.14"-16"-18" SLOTS 0,5MM*	45	201	•	
PV361	LOWER LATERAL SYSTEM 4"-8UN X D.63 PRES.VES.21"-24" SLOTS 0,5MM*	45	201	•	
PV362	LOWER LATERAL SYSTEM 4"-8UN X D.63 PRES.VES.30" SLOTS 0,5MM*	45	201	•	
PV363	LOWER LATERAL SYSTEM 4"-8UN X D.63 PRES.VES.36" SLOTS 0,5MM*	45	201	•	

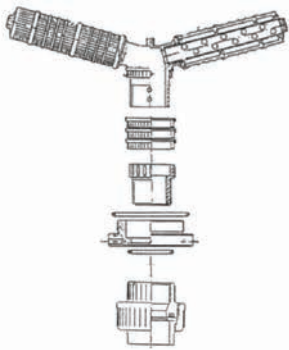

Ref	Slots (mm)	Ø Vessel	Flow(m³/h) Δp 0,2 bar	Lateral length (mm)
PV353	0,2	14" - 16" - 18"	16	113
PV354	0,2	21" - 24"	17	175
PV355	0,2	30"	18	237
PV356	0,2	36"	20	299
PV360	0,5	14" - 16" - 18"	16	113
PV361	0,5	21" - 24"	17	175
PV362	0,5	30"	18	237
PV363	0,5	36"	20	299

Certificates	Manufacturer	Sectors
		Industrial



Pressure Vessels Accessories

Lower lateral systems with 6 laterals hub for flanged pressure vessels



- Lower lateral system for 6" flanged pressure vessels;
- Flange material PVC;
- Complete with AISI 304 bolts and washer;
- Hub at 6 laterals;
- Laterals in PP, slots 0,2 or 0,5 mm, length as table below.

Ref	Description	Fam.	Subfam.	Disp. Stock	
PV520	LOWER LATERAL SYSTEM FLANG. 6" DN65 PRES.VES. 18"-21" SLOTS 0,2MM*	45	201	•	
PV521	LOWER LATERAL SYSTEM FLANG. 6" DN65 PRES.VES.24" SLOTS 0,2MM*	45	201	•	
PV522	LOWER LATERAL SYSTEM FLANG. 6" DN65 PRES.VES.30" SLOTS 0,2MM*	45	201	•	
PV523	LOWER LATERAL SYSTEM FLANG. 6" DN65 PRES.VES.36" SLOTS 0,2MM*	45	201	•	
PV524	LOWER LATERAL SYSTEM FLANG. 6"-DN65 PRES.VES. 18"-21" DIFF. 0,5MM*	45	201	•	
PV525	LOWER LATERAL SYSTEM FLANG. 6" DN65 PRES.VES.24" SLOTS 0,5MM*	45	201	•	
PV526	LOWER LATERAL SYSTEM FLANG. 6" DN65 PRES.VES. 30" SLOTS 0,5MM*	45	201	•	
PV527	LOWER LATERAL SYSTEM FLANG. 6" DN65 PRES.VES.36" SLOTS 0,5MM*	45	201	•	

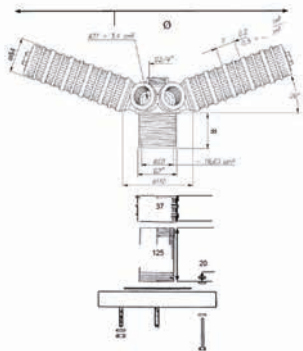

Ref	Ø Vessel	Connection	Lateral lenght (mm)	Ø Diameter (mm)	Slots (mm)	Flow (m³/h) Δ0,2 bar p
PV520	18" - 21"	DN 65	144	374	0,2	16
PV521	24"	DN 65	175	432	0,2	17
PV522	30"	DN 65	237	549	0,2	18
PV523	36"	DN 65	299	665	0,2	20
PV524	18" - 21"	DN 65	144	374	0,5	16
PV525	24"	DN 65	175	432	0,5	17
PV526	30"	DN 65	237	549	0,5	18
PV527	36"	DN 65	299	665	0,5	20

Certificates	Manufacturer	Sectors
		Industrial



Lower lateral systems with 8 laterals hub for flanged pressure vessels

- Lower lateral system for 6" flanged pressure vessels;
- Flange material PVC;
- Complete with AISI 304 bolts and washer;
- Hub at 8 laterals;
- Laterals in PP, slots 0,2 or 0,5 m

Ref	Description	Fam.	Subfam.	Disp. Stock	
PV522A	LOWER LATERAL SYSTEM FLANG. 6"-DN65 HF PRES.VES. 30" DIFF. 0,2MM*	45	201	•	
PV523A	LOWER LATERAL SYSTEM FLANG. 6" DN65 HF PRES.VES.36" SLOTS 0,2MM*	45	201	•	
PV528	LOWER LATERAL SYSTEM FLANG. 6" DN80 PRES.VES.24" SLOTS 0,2MM*	45	201	•	
PV529	LOWER LATERAL SYSTEM FLANG. 6" DN80 PRES.VES.30" SLOTS 0,2MM*	45	201	•	
PV530	LOWER LATERAL SYSTEM FLANG. 6" DN80 PRES.VES.36" SLOTS 0,2MM*	45	201	•	
PV526A	LOWER LATERAL SYSTEM FLANG. 6" DN65 HF PRES.VES.30" SLOTS 0,5MM*	45	201	•	
PV527A	LOWER LATERAL SYSTEM FLANG. 6" DN65 HF PRES.VES.36" SLOTS 0,5MM*	45	201	•	
PV531	LOWER LATERAL SYSTEM FLANG. 6" DN80 PRES.VES.24" SLOTS 0,5MM*	45	201	•	
PV532	LOWER LATERAL SYSTEM FLANG. 6" DN80 PRES.VES.30" SLOTS 0,5MM*	45	201	•	
PV533	LOWER LATERAL SYSTEM FLANG. 6" DN80 PRES.VES.36" SLOTS 0,5MM*	45	201	•	

Ref	Ø Vessel	Connection	Lateral lenght (mm)	Ø Diameter	Slots (mm)	Flow (m ³ /h) Δp 0,2 bar
PV522A	30"	DN 65	237	580	0,2	28
PV523A	36"	DN 65	299	699	0,2	30
PV528	24"	DN 80	175	461	0,2	26
PV529	30"	DN 80	237	580	0,2	28
PV530	36"	DN 80	299	699	0,2	30
PV526A	30"	DN 65	237	580	0,5	28
PV527A	36"	DN 65	299	699	0,5	30
PV531	24"	DN 80	175	461	0,5	26
PV532	30"	DN 80	237	580	0,5	28
PV533	36"	DN 80	299	699	0,5	30

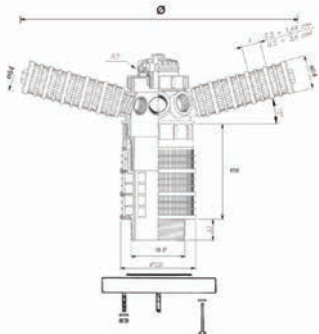

Certificates	Manufacturer	Sectors
		Industrial



Pressure Vessels Accessories

Lower double lateral systems for flanged pressure vessels

- Lower double lateral system for 6" flanged pressure vessels;
- Flange material PVC, bolts in AISI 304;
- Complete with bolts and washer;
- Double hub at 8 + 8 laterals;
- Laterals in PP, slots 0,2 or 0,5 mm, length as table below.



Ref	Description	Fam.	Subfam.	Disp. Stock	
PV555	LOWER LATERAL SYSTEM FLANG. 6" DN80 PRES.VES.63" SLOTS 0,2 MM*	45	201	•	
PV538	LOWER LATERAL SYSTEM FLANG 6" DN100 PRES. VES. 63" DIFF 0,2 MM*	45	201	•	
PV556	LOWER LATERAL SYSTEM FLANG. 6" DN80 PRES.VES.63" SLOTS 0,5 MM*	45	201	•	
PV539	LOWER LATERAL SYSTEM FLANG. 6" DN100 PRES.VES.63" SLOTS 0,5 MM*	45	201	•	

Ref	Lateral quantity	A (mm)	Slots (mm)	Flow (m3/h) Δp 0,2 bar	Diffusor lenght (mm)	Ø System diameter (mm)
PV555	8 + 8	190	0,2	50	578-640	1239-1359
PV538	8 + 8	190	0,2	60	578-640	1239-1359
PV556	8 + 8	190	0,5	50	578-640	1239-1359
PV539	8 + 8	190	0,5	60	578-640	1239-1359

Certificates	Manufacturer	Sectors
		Industrial

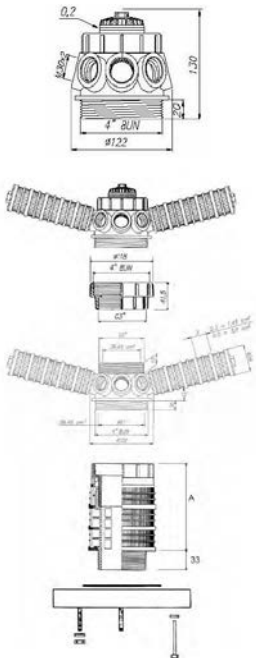

Ref	Description	Fam.	Subfam.	Disp. Stock	
PV534	LOWER LATERAL SYSTEM FLANG. 6" DN80 PRES.VES.42" SLOTS 0,2 MM*	45	201	•	
PV535	LOWER LATERAL SYSTEM FLANG. 6" DN80 PRES. VES. 48" DIFF. 0,2 MM*	45	201	•	
PV536	LOWER LATERAL SYSTEM FLANG. 6" DN80 PRES.VES.42" SLOTS 0,5 MM*	45	201	•	
PV537	LOWER LATERAL SYSTEM FLANG. 6" DN80 PRES.VES.48" SLOTS 0,5 MM*	45	201	•	

Ref	Lateral quantity	A (mm)	Slots (mm)	Flow (m3/h) Δp 0,2 bar	Diffusor lenght (mm)	Ø Systems (mm)
PV534	8 + 8	150	0,2	32	361-423	819-939
PV535	8 + 8	150	0,2	36	423-485	939-1059
PV536	8 + 8	150	0,5	32	361-423	819-939
PV537	8 + 8	150	0,5	36	423-485	939-1059

Certificates	Manufacturer	Sectors
		Industrial



Pressure Vessels Accessories

Top mount lower lateral systems for flanged pressure vessels



- Lower lateral system for 6" flanged pressure vessels for top mount valve, with 6 laterals;
- Material hub and laterals PP, length as table below;
- Slots 0,2 or 0,5 mm;
- To install with 2" adapter for the needed riser tube diameter.

Ref	Description	Fam.	Subfam.	Disp. Stock	
PV540	LOWER LATERAL SYSTEM TOP MOUNT PRES.VES. 18"-21" SLOTS 0,2 MM*	45	201	•	
PV544	LOWER LATERAL SYSTEM TOP MOUNT PRES.VES. 18"-21" SLOTS 0,5 MM*	45	201	•	

Ref	Ø Vessel	Diffusor lenght (mm)	Ø Diameter (mm)	Slots (mm)	Flow (m³/h) Δp 0,2 bar
PV540	18" - 21"	144	374	0,2	16
PV544	18" - 21"	144	374	0,5	16

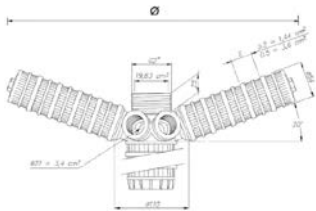

Ref	Description	Fam.	Subfam.	Disp. Stock	
PV541	LOWER LATERAL SYSTEM TOP MOUNT PRES.VES. 24" SLOTS 0,2 MM*	45	201	•	
PV545	LOWER LATERAL SYSTEM TOP MOUNT PRES.VES. 24" DIFF. 0,5 MM*	45	201	•	

Ref	Vessel	Diffusor lenght (mm)	Ø Diameter (mm)	Slots (mm)	Flow (m³/h) Δp 0,2 bar
PV541	24"	175	432	0,2	17
PV545	24"	175	432	0,5	17

Certificates	Manufacturer	Sectors
		Industrial



Pressure Vessels Accessories

Ref	Description	Fam.	Subfam.	Disp. Stock	
PV542	LOWER LATERAL SYSTEM TOP MOUNT PRES.VES. 30" SLOTS 0,2 MM*	45	201	•	
PV546	LOWER LATERAL SYSTEM TOP MOUNT PRES.VES. 30" SLOTS 0,5 MM*	45	201	•	

Ref	Ø Vessel	Diffusor lenght (mm)	Ø Diameter (mm)	Slots (mm)	Flow (m³/h) Δp 0,2 bar
PV542	30"	237	549	0,2	18
PV546	30"	237	549	0,5	18

Certificates	Manufacturer	Sectors
		Industrial

Ref	Description	Fam.	Subfam.	Disp. Stock	
PV543	LOWER LATERAL SYSTEM TOP MOUNT PRES.VES. 36" SLOTS 0,2 MM*	45	201	•	
PV547	LOWER LATERAL SYSTEM TOP MOUNT PRES.VES. 36" SLOTS 0,5 MM*	45	201	•	

Ref	Ø Vessel	Diffusor lenght (mm)	Ø Diameter (mm)	Slots (mm)	Flow (m³/h) Δp 0,2 bar
PV543	36"	299	665	0,2	20
PV547	36"	299	665	0,5	20

Certificates	Manufacturer	Sectors
		Industrial

2" gas adapter

- 2" GAS adapters with connection to glue;
- Material PVC.

Ref	Description	Fam.	Subfam.	Disp. Stock	
PV384	ADAPTER F/F 2"x41,8 MM TO GLUE	45	201	•	
PV385	ADAPTER F/F 2"x48,3 MM TO GLUE	45	201	•	
PV386	ADAPTER F/F 2"x50 MM TO GLUE	45	201	•	
PV387	ADAPTER F/F 2"x63 MM TO GLUE	45	201	•	

Ref	Description	Connection to glue (mm)
PV384	ADAPTER F/F 2"x41,8 MM TO GLUE	41,8
PV385	ADAPTER F/F 2"x48,3 MM TO GLUE	48,3
PV386	ADAPTER F/F 2"x50 MM TO GLUE	50,0
PV387	ADAPTER F/F 2"x63 MM TO GLUE	63,0

Certificates	Manufacturer	Sectors
		Industrial



Pressure Vessels Accessories

Top mount lower lateral systems for tubes diameter 90 mm

- Lower lateral system for 6" flanged pressure vessels for top mount valve, with 8 laterals;
- Material hub and laterals PP, length as table below;
- Slots 0,2;
- To glue on tube diameter 90 mm.

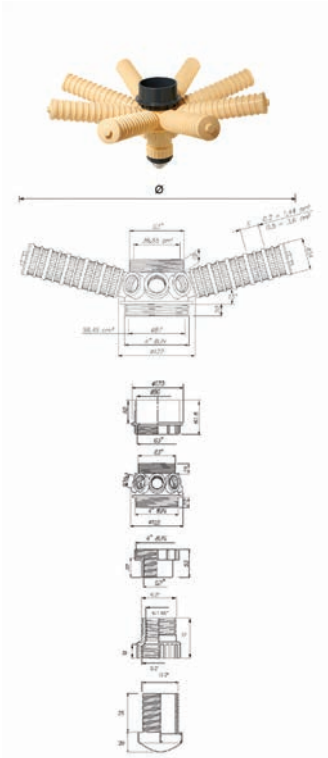

Ref	Description	Fam.	Subfam.	Disp. Stock	
PV548	LOWER LATERAL SYSTEM TOP MOUNT PRES.VES. 30" FOR TUBE 90 MM SLOTS 0,2 M	45	201	•	
PV549	LOWER LATERAL SYSTEM TOP MOUNT PRES.VES. 36" TUBE 90 MM SLOTS 0,2 MM*	45	201	•	

Ref	Diffusor lenght (mm)	Ø Diameter	Slots (mm)	Flow (m³/h) Δp 0,2 bar
PV548	237	580	0,2	28
PV549	299	699	0,2	30

Certificates	Manufacturer	Sectors
		Industrial

Top mount lower double lateral systems for tubes diameter 90 mm

- Lower lateral system for 6" flanged pressure vessels for top mount valve, with 8+8 laterals;
- Material hub and laterals PP, length as table below;
- Slots 0,2;
- To glue on tube diameter 90 mm.

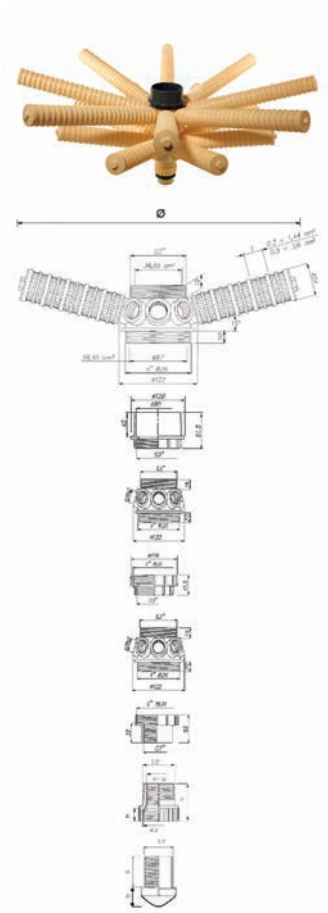

Ref	Description	Fam.	Subfam.	Disp. Stock	
PV550	LOWER LATERAL SYSTEM TOP MOUNT PRES.VES. 42" FOR TUBE 90 MM SLOTS 0,2 M	45	201	•	
PV551	LOWER LATERAL SYSTEM TOP MOUNT PRES.VES. 48" TUBE 90 MM SLOTS 0,2 MM*	45	201	•	

Ref	Laterals quantity	Lateral lenght (mm)	Ø Diameter (mm)	Slots(mm)	Flow (m³/h) Δp 0,2 bar
PV550	8 + 8	299-423	699-939	0,2	31
PV551	8 + 8	361-485	361-485	0,2	34

Box: WxLxH	Box: Q.ty	Box: Weight	Pallet: WxLxH	Pallet: Q.ty	Pallet: Weight

Certificates	Manufacturer	Sectors
		Industrial



Pressure Vessels Accessories

Cylindrical laterals

- Cylindrical laterals with threaded connection M 30x2;
- Material PP;
- Diameter 54 mm;
- Slots 0,2 or 0,5 mm.



Laterals with 0,2 mm slots

Ref	Description	Fam.	Subfam.	Disp. Stock	
PV345	LATERAL DIFFUSER M 30 X 2 L=113 - 0,2 MM	45	201	•	
PV370	LATERAL DISTRIBUTOR M 30X2 L=144 - 0,2MM	45	201	•	
PV346	LATERAL DIFFUSER M 30 X 2 L=175 - 0,2 MM	45	201	•	
PV371	LATERAL DISTRIBUTOR M 30X2 L=206 - 0,2MM	45	201	•	
PV347	LATERAL DIFFUSER M 30 X 2 L=237 - 0,2 MM	45	201	•	
PV348	LATERAL DIFFUSER M 30 X 2 L=299 - 0,2 MM	45	201	•	
PV372	LATERAL DISTRIBUTOR M 30X2 L=361 - 0,2MM	45	201	•	
PV373	LATERAL DISTRIBUTOR M 30X2 L=423 - 0,2MM	45	201	•	
PV374	LATERAL DISTRIBUTOR M 30X2 L=485 - 0,2MM	45	201	•	
PV389	LATERAL DIFFUSER M 30X2 L=578 - 0,2 MM	45	201	•	
PV391	LATERAL DIFFUSER M30x2 L = 640 MM SLOTS 0,2 MM	45	201	•	

Ref	Description	L (mm)
PV345	LATERAL DIFFUSER M 30 X 2 L=113 - 0,2 MM	113
PV370	LATERAL DISTRIBUTOR M 30X2 L=144 - 0,2MM	144
PV346	LATERAL DIFFUSER M 30 X 2 L=175 - 0,2 MM	175
PV371	LATERAL DISTRIBUTOR M 30X2 L=206 - 0,2MM	206
PV347	LATERAL DIFFUSER M 30 X 2 L=237 - 0,2 MM	237
PV348	LATERAL DIFFUSER M 30 X 2 L=299 - 0,2 MM	299
PV372	LATERAL DISTRIBUTOR M 30X2 L=361 - 0,2MM	361
PV373	LATERAL DISTRIBUTOR M 30X2 L=423 - 0,2MM	423
PV374	LATERAL DISTRIBUTOR M 30X2 L=485 - 0,2MM	485
PV389	LATERAL DIFFUSER M 30X2 L=578 - 0,2 MM	578
PV391	LATERAL DIFFUSER M30x2 L = 640 MM SLOTS 0,2 MM	640

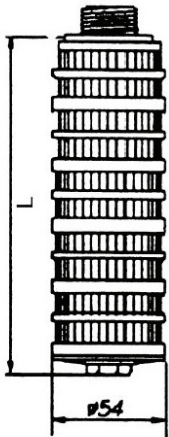

Certificates	Manufacturer	Sectors
		Industrial



Cylindrical laterals

- Cylindrical laterals with threaded connection M 30x2;
- Material PP;
- Diameter 54 mm;
- Slots 0,2 or 0,5 mm.

Laterals with 0,5 mm slots

Ref	Description	Fam.	Subfam.	Disp. Stock	
PV375	LATERAL DISTRIBUTOR M 30X2 L=113 - 0,5MM	45	201	•	
PV376	LATERAL DISTRIBUTOR M 30X2 L=144 - 0,5MM	45	201	•	
PV377	LATERAL DISTRIBUTOR M 30X2 L=175 - 0,5MM	45	201	•	
PV378	LATERAL DISTRIBUTOR M 30X2 L=206 - 0,5MM	45	201	•	
PV379	LATERAL DISTRIBUTOR M 30X2 L=237 - 0,5MM	45	201	•	
PV380	LATERAL DISTRIBUTOR M 30X2 L=299 - 0,5MM	45	201	•	
PV381	LATERAL DISTRIBUTOR M 30X2 L=361 - 0,5MM	45	201	•	
PV382	LATERAL DISTRIBUTOR M 30X2 L=423 - 0,5MM	45	201	•	
PV383	LATERAL DISTRIBUTOR M 30X2 L=485 - 0,5MM	45	201	•	
PV390	LATERAL DIFFUSER M30x2 L = 578 MM SLOTS 0,5 MM	45	201	•	
PV392	LATERAL DIFFUSER M 30X2 L=640 - 0,5 MM	45	201	•	

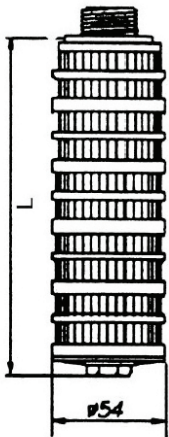

Ref	Description	L (mm)
PV375	LATERAL DISTRIBUTOR M 30X2 L=113 - 0,5MM	113
PV376	LATERAL DISTRIBUTOR M 30X2 L=144 - 0,5MM	144
PV377	LATERAL DISTRIBUTOR M 30X2 L=175 - 0,5MM	175
PV378	LATERAL DISTRIBUTOR M 30X2 L=206 - 0,5MM	206
PV379	LATERAL DISTRIBUTOR M 30X2 L=237 - 0,5MM	237
PV380	LATERAL DISTRIBUTOR M 30X2 L=299 - 0,5MM	299
PV381	LATERAL DISTRIBUTOR M 30X2 L=361 - 0,5MM	361
PV382	LATERAL DISTRIBUTOR M 30X2 L=423 - 0,5MM	423
PV383	LATERAL DISTRIBUTOR M 30X2 L=485 - 0,5MM	485
PV390	LATERAL DIFFUSER M30x2 L = 578 MM SLOTS 0,5 MM	578
PV392	LATERAL DIFFUSER M 30X2 L=640 - 0,5 MM	640

Certificates	Manufacturer	Sectors
		Industrial



Pressure Vessels Accessories

Flange coupling kit



- For 6" flanged pressure vessels;
- Including flange adaptor and coupling flange in PVC;
- With gasket in EPDM.

Ref	Description	Fam.	Subfam.	Disp. Stock	
PV594M	FLANGE COUPLING KIT DN65-D75-2"1/2	45	210	•	
PV595M	FLANGE COUPLING KIT DN80-D90-3"	45	210	•	
PV596M	FLANGE COUPLING KIT DN100-D110-4"	45	210	•	

Ref	Description	Connection
PV594M	FLANGE COUPLING KIT DN65-D75-2"1/2	DN65
PV595M	FLANGE COUPLING KIT DN80-D90-3"	DN80
PV596M	FLANGE COUPLING KIT DN100-D110-4"	DN100

Certificates	Manufacturer	Sectors
		Industrial

PV295



PV395



Mineral tank funnels

- The tank funnels are designed for filling mineral tanks with granular media and ion exchange resin;
- The funnels are designed to fit 2,5", 4" and 6" mineral tank openings;
- These economical funnels are nestable to reduce shipping and storage costs;
- The funnel ref. PV395 snaps into a 4" or 6" mineral tank opening for stability when pouring media. The neck of the funnel has been carefully designed to allow trapped air inside the mineral tank to escape when media is poured in. This heavy duty part is blow molded out of high density polyethylene for exceptional strength and durability. The oval design provides an extra wide opening for ease of use when pouring. Handles are molded into the funnel for added convenience.

Ref	Description	Fam.	Subfam.	Disp. Stock	
PV295	MINERAL TANK FUNNEL 2.5"	45	196	•	
PV395	MINERAL TANK FUNNEL 4" - 6"	45	201	•	

Certificates	Manufacturer	Sectors
		Domestic, Commercial, Industrial



WELLMATE Pressure Vessels



- Pressure Vessels, suitable for industrial and potable water treatment systems;
- Made in U.S.A.;
- In Polyether Urethane (PEU);
- Max operating external temperature 50°C;
- Max operating internal temperature 38°C;
- Min. operating temperature 4°C;
- Grey colour;
- Warranty 5 years.

Ref	Description	Fam.	Subfam.	Disp. Stock	
BWM0060	WELLMATE PEU 8.5 BAR - 55 LT - 1"	100	460		
BWM0075	WELLMATE PEU 8.5 BAR - 75 LT - 1"	100	460		
BWM0120	WELLMATE PEU 8.5 BAR - 112 LT - 1"	100	460		
BWM-HP-110	WELLMATE HYDROPNEUMATIC 5 BAR - 114 LT - 1 1/4"	100	460		
BWM-HP-150	WELLMATE HYDROPNEUMATIC 5 BAR - 151 LT - 1 1/4"	100	460		
BWM0150	WELLMATE PEU 8.5 BAR - 153 LT - 1"	100	460		
BWM-HP-300	WELLMATE HYDROPNEUMATIC 5 BAR - 303 LT - 1 1/4"	100	460		
BWM0180	WELLMATE PEU 8.5 BAR - 178 LT - 1" 1/4"	100	460		
BWM0235	WELLMATE PEU 8.5 BAR - 235 LT - 1" 1/4"	100	460		
BWM0330	WELLMATE PEU 8.5 BAR - 328 LT - 1" 1/4"	100	460		
BWM0450	WELLMATE PEU 8.5 BAR - 453 LT - 1" 1/4"	100	460		
BWM-LP-075	WELLMATE PEU LOW PROFILE 8.5 BAR - 73 LT - 1"	100	460		
BWM-LP-130	WELLMATE PEU LOW PROFILE 8.5 BAR - 131 LT - 1"	100	460		
BWM-HP-450	WELLMATE HYDROPNEUMATIC 5 BAR - 454 LT - 1 1/4"	100	460		

Ref	Diameter (mm)	Total Height (mm)	In-Out Height from the floor(mm)	Connection (Inch)	Weight (kg)
BWM0060	410	660	44	1" NPT M	7
BWM0075	410	810	44	1" NPT M	8
BWM0120	410	1120	44	1" NPT M	11
BWM-HP-110	410	1110	38	1" 1/4" NPT M	12
BWM-HP-150	410	1440	38	1" 1/4" NPT M	13
BWM0150	530	1570	57	1" NPT M	30
BWM-HP-300	530	1570	51	1" 1/4" NPT M	16
BWM0180	610	1050	57	1" 1/4" NPT M	23
BWM0235	610	1400	57	1" 1/4" NPT M	33
BWM0330	610	1400	57	1" 1/4" NPT M	33
BWM0450	610	1890	57	1" 1/4" NPT M	43
BWM-LP-075	610	510	57	1" NPT M	11
BWM-LP-130	610	710	57	1" NPT M	14
BWM-HP-450	610	1840	51	1" 1/4" NPT M	29

Certificates	Manufacturer	Sectors
NSF 61, WRAS, CE	Pentair	Domestic

**Accessories and Spare Parts:**

Ref	Description	Fam.	Subfam.	Disp. Stock	
BWM-AC-0060	MEMBRANE FOR BWM0060	100	462		
BWM-AC-0075	MEMBRANE FOR BWM0075	100	462		
BWM-AC-0180	MEMBRANE FOR BWM0180	100	462		
BWM-AC-0235	MEMBRANE FOR BWM0235	100	462		
BWM-AC-0330	MEMBRANE FOR BWM0330	100	462		
BWM-AC-0450	MEMBRANE FOR BWM0450	100	462		
BWM-AC-0600	AIRCELL REPLACEMENT KIT FOR BWM0600	100	462		
BWM-AVC-20290	AIR VOLUME CONTROL ASSEMBLY FOR BWM-HP-110	100	462		
BWM-AVC-20288	AIR VOLUME CONTROL ASSEMBLY FOR BWM-HP-150	100	462		
BWM-AVC-20287	AIR VOLUME CONTROL ASSEMBLY FOR BWM-HP-300	100	462		
BWM-AVC-20291	AIR VOLUME CONTROL ASSEMBLY FOR BWM-HP-450	100	462		
BWM-AVC-1	AIR VOLUME CONTROL ASSEMBLY FOR BWM-HP/UT	100	462		
BWM-BA-20513	WELLMATE BASE 180/300	100	462		
BWM-DA-3174	WM SCREEN & ADAPT. ASSY + O-RING - 4"x2" NPSM	100	462		
BWM-DA-HU79	WM BOTTOM DRAIN + 1 1/4" NPT THREADED PIPES HP110-150	100	462		
BWM-DA-HU86	WM BOTTOM DRAIN + 1 1/4" NPT THREADED PIPES HP300-450	100	462		
BWM-PB-001	WM PUMP MOUNT BRACKET	100	462		
BWM-AI-01	WM AIR INJECTOR/MICRONIZER-HP	100	462		
BWM-VB-10724	WM VACUUM BREAKER UT/HP	100	462		
BWM-CL-0002	WM "H" CLIP	100	462		