



Brine
tanks



Residential Square Brine Tank



- Made in European Union (Italy);
- Brine tank material HDPE;
- Complete with cover in ABS;
- Dimensions 380 x 380 mm, height 790 mm;
- Capacity 85 liters;
- Available multiple packaging of 30 pcs per pallet;
- EU design patent no. 003156272.



REF.	TANK COLOUR	COVER COLOUR	
T0085QWQA	White	Blue	
T0085QWQW	White	White	
T0085QWQD	White	Black	

Accessories:

Salt Grid

- Made in European Union (Italy);
- Material HDPE;
- Height 200 mm;
- Hole for brine well diameter 100 mm;
- Salt gride holes \square 3 mm.



REF.	
PC006	

Brine well

- Material PVC with cover;
- Diameter 100 mm;
- Height 640 mm.

REF.	
PA007	



Residential Round Brine Tanks



- Made in European Union (Italy);
- Brine tanks complete with cover;
- Material PE medium density, rotomolded;
- Single or multiple packaging of 20 pcs per pallet for 100 liters and 140 liters brine tanks and 16 pcs per pallet for 190 liters brine tanks;
- Colour white opaque UVA ray resistant;
- Cover colours available: white, blue or black;
- EU design patent no. 003156272.

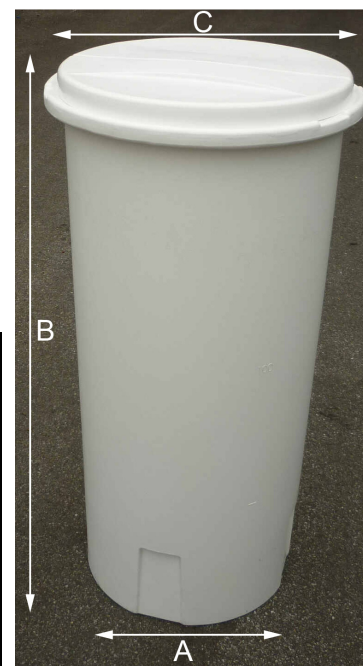

REF.	CAPACITY (LITERS)	COVER COLOUR	OVERALL DIMENSIONS		
			A (mm)	B (mm)	C (mm)
T0100CWCW	100	White	460	616	565
T0100CWCA	100	Blue	460	616	565
T0100CWCD	100	Black	460	616	565
T0140CWCW	140	White	460	843	565
T0140CWCA	140	Blue	460	843	565
T0140CWCD	140	Black	460	843	565
T0190CWCW	190	White	460	1123	565
T0190CWCA	190	Blue	460	1123	565
T0190CWCD	190	Black	460	1123	565

Accessories:

Salt grids

- Made in European Union (Italy);
- Material PE medium density;
- Hole for brine well diameter 100 mm;
- Salt gride holes \square 3 mm.



REF.	HEIGHT (mm)	DIAMETER (mm)
PC031	130	475
PC032	200	475
PC033	270	475



Brine well

- Material PVC with cover;
- Diameter 100 mm.

REF.	HEIGHT (mm)	FOR BRINE TANKS (liters)
PA075	520	100
PA010	690	140
PA015	970	190

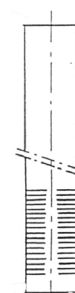

Industrial Round Brine Tanks



- Made in European Union (Italy);
- Brine tanks complete with cover;
- Material PE medium density, rotomolded;
- Single or multiple packaging of 3 pcs per pallet;
- Colour white opaque UVA ray resistant;
- Cover colours available: white, blue or black;
- EU design patent no. 003156272.

REF.	CAPACITY (LITERS)	COVER COLOUR	OVERALL DIMENSIONS		
			A (mm)	B (mm)	C (mm)
T0340CWCW	340	White	594	1200	723
T0340CWCA	340	Blue	594	1200	723
T0340CWCD	340	Black	594	1200	723
T0460CWCW	460	White	703	1196	833
T0460CWCA	460	Blue	703	1196	833
T0460CWCD	460	Black	703	1196	833

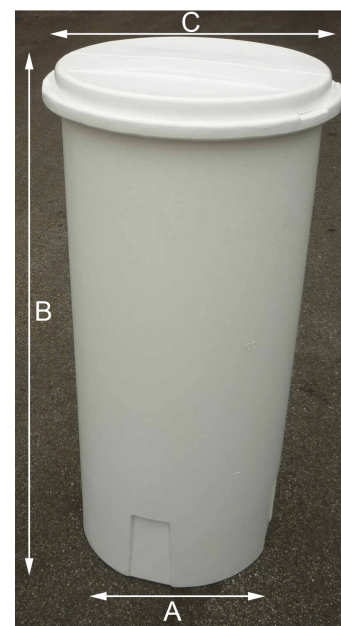

Accessories:

Salt grids

- Made in European Union (Italy);
- Material PE medium density;
- Hole for brine well diameter 160 mm;
- Salt gride holes $\varnothing = 5$ mm.

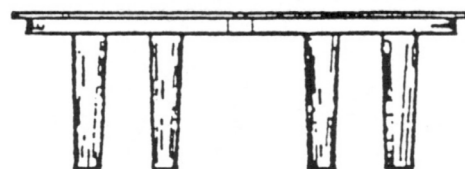

REF.	HEIGHT (mm)	DIAMETER (mm)	FOR BRINE TANKS (liters)
PC070	375	600	340
PC071	375	700	460

Brine well

- Material PVC with cover;
- Diameter 160 mm;
- Height 1050 mm.

REF.	
PA016	



Industrial Round Brine Tanks



- Made in European Union (Italy);
- Brine tanks complete with cover;
- Material PE medium density, rotomolded;
- Single or multiple packaging of 3 pcs per pallet;
- Colour white opaque UVA ray resistant;
- Cover colours available: white, blue or black;
- EU design patent no. 003156272.

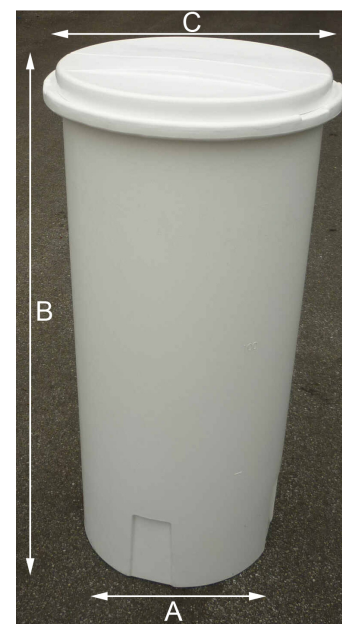

REF.	CAPACITY (LITERS)	COVER COLOUR	OVERALL DIMENSIONS		
			A (mm)	B (mm)	C (mm)
T0670CWCW	670	White	847	1196	973
T0670CWCA	670	Blue	847	1196	973
T0670CWCD	670	Black	847	1196	973
T0920CWCW	920	White	997	1206	1123
T0920CWCA	920	Blue	997	1206	1123
T0920CWCD	920	Black	997	1206	1123

Accessories:

Salt grids

- Made in European Union (Italy);
- Material PE medium density;
- Hole for brine well diameter 160 mm;
- Salt gride holes $\varnothing = 5$ mm.

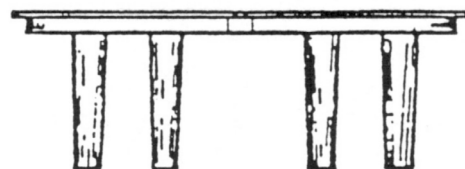

REF.	HEIGHT (mm)	DIAMETER (mm)	FOR BRINE TANKS (liters)
PC072	375	835	670
PC073	375	1010	920

Brine well

- Material PVC with cover;
- Diameter 160 mm;
- Height 1050 mm.

REF.
PA016



Potassium Permanganate Feeder



- feeder for potassium permanganate solution, to realize automatic iron removal systems with manganese greensand;
- complete with floating valve, well, special grid for permanganate, overflow, safety screw for cover;
- material: polyethylene;
- dimensions: diameter 266 mm, height 420 mm;
- storage KMnO_4 capacity: 13,6 kg;
- connection for $\frac{3}{8}$ " tubing;
- colour black.

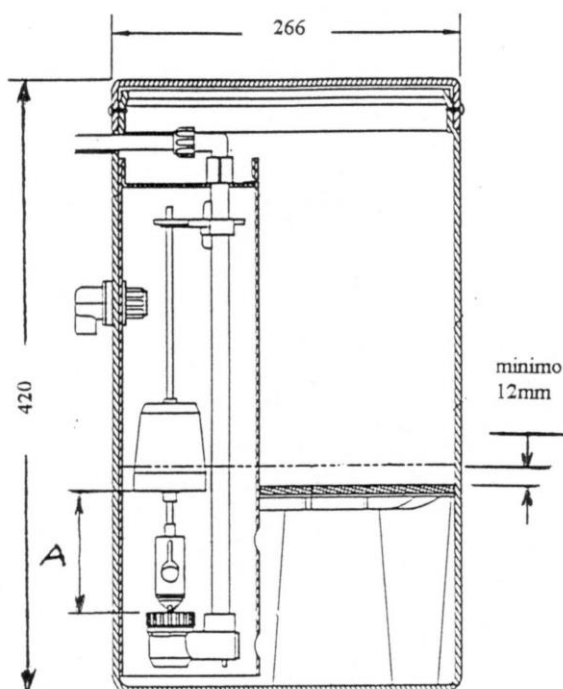

REF.	
AV120	

Float setting:

Suggested dose of regenerant: $2 \div 4$ g KMnO_4 per greensand liter

KMnO_4 solution: 30 g/l at 10°C
60 g/l at 22°C

Minimum A floating setting at 108 mm is equivalent to 4 liters of solution.