



Valves,
controllers
and accessories



366-604 Autotrol Residential Valves



- for automatic and residential water softening systems;
- valve body in NSF listed Noryl plastic material;
- valve rubber compounded for cold water, NSF listed material;
- operating flow rate $K_v = 2$;
- backwash flow rate = 7 lpm @ Δp 1,72 bar;
- resin volume range = 5 ÷ 25 litres;
- with 606 electronic volumetric controller;
- with European transformer 12/230V – 50Hz;
- accessories (e.g. upper screen, etc.) not included.



Characteristics	
Pressure vessel connection	Threaded 2 1/2" - 8 UN male
Brine line connection	Threaded 3/8" BSPT male
Distributor tube O. D. diameter	1,05" (= 27 mm)
Distributor tube length above pressure vessel	± 1/2" (= ± 13 mm)
Weight (valve + controller)	1,7 kg
Operating pressure	1,38 ÷ 8,27 bar
Water temperature	2°C ÷ 38°C

Model	Description	
366/604	Electronic Chronometric	

Autotrol Residential Valves Series 368



- For automatic and residential water softening systems;
- Valve body in NSF listed Noryl plastic material;
- Valve rubber compounded for cold water, NSF listed material;
- Operating flow rate Kv = 3,68;
- Backwash flow rate = 10 lpm @ Δp 1,72 bar;
- Resin volume range = 5 ÷ 25 litres;
- Available with the following controllers:
 - 604 electronic chronometric;
 - 606 electronic volumetric;
- With European transformer 12/230V – 50Hz;
- Accessories (e.g. upper screen, etc.) not included;
- Programmable chronometric regeneration (calendar override) and consumption statistical data memory.



Characteristics	
Pressure vessel connection	Threaded 2 ½" - 8 UN male
Brine line connection	Threaded ⅜" BSPT male
Distributor tube O. D. diameter	1,05" (= 27 mm)
Distributor tube length above pressure vessel	± ½" (= ± 13 mm)
Weight (valve + controller)	1,7 kg
Operating pressure	1,38 ÷ 8,27 bar
Water temperature	2°C ÷ 38°C

Model	Description
368/604	Electronic Chronometric
368/606 (*)	Electronic Volumetric
368/606B	Electronic volumetric with bypass

(*) NOTE: It's not possible to coupling the bypass with a valve shipped without bypass



Autotrol Residential Valves Series 255 with Series 400 Controller



- for automatic and residential water softening systems;
- valve body in NSF listed Noryl plastic material;
- valve rubber compounded for cold water, NSF listed material;
- operating flow rate $K_v = 3,4$;
- backwash flow rate = 22,7 lpm @ Δp 1,72 bar;
- resin volume range = 5 ÷ 75 litres;
- available with series 400 controller (see 01-03-01-EN data sheet):
 - 460tc electronic chronometric;
 - 460i electronic volumetric;
- with European transformer 12/230V – 50Hz, except models with 450i pulse controller which need separate alimentation 24V – 50Hz;
- adapters and manifold kit not included, to order separately: see 01-04-01-EN and 01-04-05-EN data sheets;
- accessories (e.g. upper screen, etc.) not included.



Characteristics	
Pressure vessel connection	Threaded 2 ½" - 8 UN male
Brine line connection	Threaded ¼" NPT male
Distributor tube O. D. diameter	1,05" (= 27 mm)
Distributor tube length above pressure vessel	29 ± 3 mm
Weight (valve + controller)	1,8 kg
Operating pressure	1,38 ÷ 8,27 bar
Water temperature	2°C ÷ 38°C

Model	Description	Option	
255/460tc	Electronic Chronometric: 118'	59'	
255/460tc	Electronic Chronometric 118' modular camshaft	XS	
255/460i	Electronic Volumetric 118'	59'	
255/460i	Electronic Volumetric modular camshaft	XS-LR-WS	

Autotrol Residential Valves Series 255 with Series Logix Controller



- for automatic and residential water softening systems;
- valve body in NSF listed Noryl plastic material;
- valve rubber compounded for cold water, NSF listed material;
- operating flow rate $K_v = 3,4$;
- backwash flow rate = 22,7 lpm @ Δp 1,72 bar;
- resin volume range = 5 ÷ 75 litres;
- available with series LOGIX controller (see 01-03-02-EN data sheet):
 - 740 C electronic chronometric;
 - 760 C electronic volumetric;
 - 742 C electronic chronometric programmable;
 - 762 C electronic volumetric programmable;
- with European transformer 12/230V – 50Hz;
- adapters and manifold kit not included, to order separately:
see 01-04-01-EN and 01-04-05-EN data sheets;
- accessories (e.g. upper screen, etc.) not included.



Characteristics	
Pressure vessel connection	Threaded 2 ½" - 8 UN male
Brine line connection	Threaded ¼" NPT male
Distributor tube O. D. diameter	1,05" (= 27 mm)
Distributor tube length above pressure vessel	29 ± 3 mm
Weight (valve + controller)	1,8 kg
Operating pressure	1,38 ÷ 8,27 bar
Water temperature	2°C ÷ 38°C

Model	Description
255/740 Logix	Electronic Chronometric
255/742 Logix	Electronic Chronometric Programmable
255/760 Logix	Electronic Volumetric
255/762 Logix	Electronic Volumetric Programmable

Residential Duplex Systems with Autotrol Valves Series 255 Twin and 764 Controller



- for automatic and residential / commercial water softening systems;
- for twin alternating and twin parallel systems;
- consisting of n.2 valves (one “main” and another one “secondary”) with 764 electronic volumetric (see 01-03-02-EN data sheet);
- with European transformer 12/230V – 50Hz;
- valve body in NSF listed Noryl plastic material;
- valve rubber compounded for cold water, NSF listed material;
- operating flow rate for each tank $K_v = 3,4$;
- backwash flow rate for each tank = 22,7 lpm @ Δp 1,72 bar;
- resin volume range for each tank = 5 ÷ 75 litres;
- interconnection kit (REF. AV119, see 01-04-01-EN data sheet) and accessories (e.g. upper screen, etc.) not included, to order separately: see 01-04-05-EN data sheet



Characteristics	
Pressure vessel connection	Threaded 2 ½”- 8 UN male
Drain line connection	Threaded ½” male, included in interconnection kit
Brine line connection	Threaded ¼” NPT male
Distributor tube O. D. diameter	1,05 ” (= 27 mm)
Distributor tube length above pressure vessel	29 ± 3 mm
Weight (valve + controller)	1,8 kg
Operating pressure	1,38 ÷ 8,27 bar
Water temperature	2°C ÷ 38°C

Model	Description	
255/764 TWIN	255/764 twin w/o interconnecting piping	

Autotrol Residential Valves Series 255 with 764 Controller for Multitank Systems



- for automatic and residential / commercial water softening systems;
- with electronic volumetric 764 controller (see 01-03-02-EN data sheet);
- for alternating systems;
- valve body in NSF listed Noryl plastic material;
- valve rubber compounded for cold water, NSF listed material;
- operating flow rate for each tank $K_v = 3,4$;
- backwash flow rate for each tank = 22,7 lpm @ Δp 1,72 bar;
- resin volume range for each tank = 5 ÷ 75 litres;
- with European transformer 12/230V – 50Hz for each valve;
- adapters and manifold kit not included, to order separately:
see 01-04-01-EN and 01-04-05-EN data sheets;
- accessories (e.g. upper screen, etc.) not included.



Characteristics	
Pressure vessel connection	Threaded 2 ½" - 8 UN male
Brine line connection	Threaded ¼" NPT male
Distributor tube O. D. diameter	1,05" (= 27 mm)
Distributor tube length above pressure vessel	29 ± 3 mm
Weight (valve + controller)	1,8 kg
Operating pressure	1,38 ÷ 8,27 bar
Water temperature	2°C ÷ 38°C

Model	Description	
255/764 SIN	255/764 single multi tank Volumetric	

Autotrol Residential Valves Series 268 with Series 400 Controller



- for automatic and residential water softening systems;
- valve body in NSF listed Noryl plastic material;
- valve rubber compounded for cold water, NSF listed material;
- operating flow rate Kv = 5,6;
- backwash flow rate = 50,4 lpm @ Δp 1,7 bar;
- resin volume range = 30 ÷ 125 litres;
- available with series 400 controller (see 01-03-01-EN data sheet):
 - 460tc electronic chronometric;
 - 460i electronic volumetric;
- with European transformer 12/230V – 50Hz;
- adapters and manifold kit not included, to order separately:
see 01-04-02-EN and 01-04-05-EN data sheets;
- accessories (e.g. upper screen, etc.) not included.

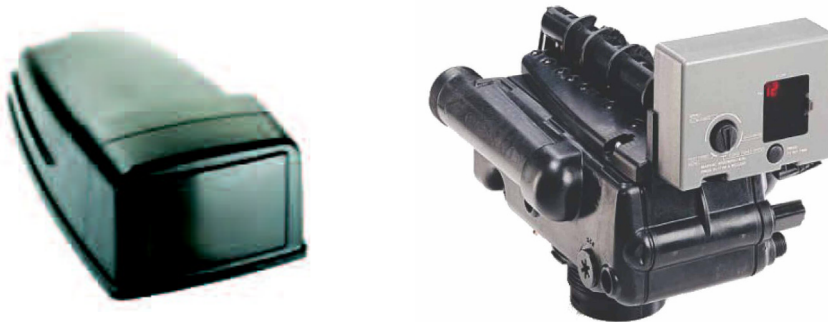

Characteristics	
Pressure vessel connection	Threaded 2 ½" - 8 UN male
Drain line connection	Threaded ¾" NPT, male
Brine line connection	Threaded ¾" NPT, male
Distributor tube O. D. diameter	1,05" (= 27 mm)
Distributor tube length above pressure vessel	29 ± 3 mm
Weight (valve + controller)	2,00 kg
Operating pressure	1,38 ÷ 8,27 bar
Water temperature	2°C ÷ 38°C

Model	Description	Option	
268/460tc	Electronic Chronometric: 118'	XS	
268/460i	Electronic Volumetric: 118'	XS	

Autotrol Residential Valves Series 263 with 460tc Controller



- for automatic and residential water filtration systems;
- with 460tc electronic chronometric controller (see 01-03-01-EN data sheet);
- valve body in NSF listed Noryl plastic material;
- valve rubber compounded for cold water, NSF listed material;
- operating flow rate $K_v = 5,6$;
- backwash flow rate = 75,7 lpm @ Δp 1,72 bar;
- with European transformer 12/230V – 50Hz;
- adapters and manifold kit not included, to order separately:
see 01-04-02-EN and 01-04-05-EN data sheets;
- accessories (ex. upper screen, etc.) not included.



Characteristics	
Pressure vessel connection	Threaded 2 ½" - 8 UN male
Drain line connection	Threaded ¾" NPT, male
Distributor tube O. D. diameter	1,05" (= 27 mm)
Distributor tube length above pressure vessel	29 ± 3 mm
Weight (valve + controller)	2,00 kg
Pressure vessel connection	Threaded 2 ½" - 8 UN male
Operating pressure	1,38 ÷ 8,27 bar
Water temperature	2°C ÷ 38°C

Model	Description	
263/460tc	Electronic Chronometric: 118' 3 filter cycles	

Autotrol Residential Valves Series 268 with Series Logix Controller



- for automatic and residential water softening systems;
- valve body in NSF listed Noryl plastic material;
- valve rubber compounded for cold water, NSF listed material;
- operating flow rate Kv = 5,6;
- backwash flow rate = 75,7 lpm @ Δp 1,72 bar;
- resin volume range = 30 ÷ 125 litres;
- available with series LOGIX controller (see 01-03-02-EN data sheet):
 - 740 C electronic chronometric;
 - 760 C electronic volumetric;
 - 742 C electronic chronometric programmable;
 - 762 C electronic volumetric programmable;
- with European transformer 12/230V – 50Hz;
- adapters and manifold kit not included, to order separately:
see 01-04-02-EN and 01-04-05-EN data sheets;
- accessories (e.g. upper screen, etc.) not included;
- for 268FA/742 and 268FA/762 models see 01-01-10-EN data sheet.



Characteristics	
Pressure vessel connection	Threaded 2 ½" - 8 UN male
Drain line connection	Threaded ¾" NPT, male
Brine line connection	Threaded ¾" NPT, male
Distributor tube O. D. diameter	1,05" (= 27 mm)
Distributor tube length above pressure vessel	½" ± ½" (= 13 ± 13 mm)
Weight (valve + controller)	2,42 kg
Operating pressure	1,38 ÷ 8,27 bar
Water temperature	2°C ÷ 38°C

Model	Description	
268/740 Logix	Electronic Chronometric	
268/742 Logix	Electronic Chronometric Programmable	
268/760 Logix	Electronic Volumetric	
268/762 Logix	Electronic Volumetric Programmable	

Autotrol Residential Valves Series 263 with Series Logix Controller



- for automatic and residential water filtration systems;
- valve body in NSF listed Noryl plastic material;
- valve rubber compounded for cold water, NSF listed material;
- operating flow rate $K_v = 5,6$;
- backwash flow rate = 75,7 lpm @ Δp 1,72 bar;
- available with series LOGIX controller (see 01-03-02-EN data sheet):
 - 740 F electronic chronometric;
 - 760 F electronic volumetric;
 - 742 F electronic chronometric programmable;
 - 762 F electronic volumetric programmable;
- with European transformer 12/230V – 50Hz;
- adapters and manifold kit not included, to order separately: see 01-04-02-EN and 01-04-05-EN data sheets;
- accessories (e.g. upper screen, etc.) not included.



Characteristics	
Pressure vessel connection	Threaded 2 ½" - 8 UN male
Drain line connection	Threaded ¾" NPT, male
Distributor tube O. D. diameter	1,05" (= 27 mm)
Distributor tube length above pressure vessel	½" ± ½" (= 13 ± 13 mm)
Weight (valve + controller)	2,42 kg
Pressure vessel connection	Threaded 2 ½" - 8 UN male
Operating pressure	1,38 ÷ 8,27 bar
Water temperature	2°C ÷ 38°C

Model	Description	
263/740F Logix	Electronic Chronometric – 3 filter cycles	
263/742F Logix	Electronic Chronometric Programmable – 3 filter cycles	
263/760F Logix	Electronic Volumetric – 3 cycles filter	
263/762F Logix	Electronic Volumetric Programmable – 3 filter cycles	

Autotrol Residential Valves Series 268FA with Series Logix Controller



- for automatic and residential water 5 cycles iron removal systems;
- valve body in NSF listed Noryl plastic material;
- valve rubber compounded for cold water, NSF listed material;
- operating flow rate Kv = 5,6;
- backwash flow rate = 75,7 lpm @ Δp 1,72 bar;
- available with series LOGIX controller (see 01-03-02-EN data sheet):
 - 742 F electronic chronometric programmable;
 - 762 F electronic volumetric programmable;
- with European transformer 12/230V – 50Hz;
- adapters and manifold kit not included, to order separately:
see 01-04-02-EN and 01-04-05-EN data sheets;
- accessories (e.g. upper screen, etc.) not included.



Characteristics	
Pressure vessel connection	Threaded 2 ½" - 8 UN male
Drain line connection	Threaded ¾" NPT, male
Distributor tube O. D. diameter	1,05" (= 27 mm)
Distributor tube length above pressure vessel	½" ± ½" (= 13 ± 13 mm)
Weight (valve + controller)	2,42 kg
Pressure vessel connection	Threaded 2 ½" - 8 UN male
Operating pressure	1,38 ÷ 8,27 bar
Water temperature	2°C ÷ 38°C

Model	Description	
268FA/742 Logix	Electronic Chronometric Programmable – 5 filter cycles	

Autotrol Residential Valves Series 278 with Series Logix Controller



- for automatic water softening systems with high resin volume;
- valve body in NSF listed Noryl plastic material;
- valve rubber compounded for cold water, NSF listed material;
- operating flow rate $K_v = 5,6$;
- backwash flow rate = 75,7 lpm @ Δp 1,72 bar;
- resin volume range = 45 ÷ 225 litres;
- available with series LOGIX controller (see 01-03-02-EN data sheet):
 - 742 C electronic chronometric programmable;
 - 762 C electronic volumetric programmable;
- with European transformer 12/230V – 50Hz;
- adapters and manifold kit not included, to order separately:
see 01-04-02-EN and 01-04-05-EN data sheets;
- accessories (e.g. upper screen, etc.) not included



Characteristics	
Pressure vessel connection	Threaded 2 ½" - 8 UN male
Drain line connection	Threaded ¾" NPT, male
Brine line connection	Threaded ¾" NPT, male
Distributor tube O. D. diameter	1,05" (= 27 mm)
Distributor tube length above pressure vessel	½" ± ½" (= 13 ± 13 mm)
Weight (valve + controller)	2,42 kg
Operating pressure	1,38 ÷ 8,27 bar
Water temperature	2°C ÷ 38°C

Model	Description	
278/742 Logix	Electronic Chronometric Programmable	
278/762 Logix	Electronic Volumetric Programmable	

Residential Duplex Systems with Autotrol Residential Valves Series 278 Twin and 764 Controller



- for automatic and residential / commercial water softening systems;
- for twin alternating and twin parallel systems;
- consisting of n.2 valves (one “main” and another one “secondary”) with 764 electronic volumetric (see 01-03-02-EN data sheet);
- with European transformer 12/230V – 50Hz;
- valve body in NSF listed Noryl plastic material;
- valve rubber compounded for cold water, NSF listed material;
- operating flow rate for each tank $K_v = 5,6$;
- backwash flow rate for each tank = 75,7 lpm @ Δp 1,72 bar;
- resin volume range for each tank = 45 ÷ 225 litres;
- interconnection kit (see 01-04-03-EN data sheet) and accessories (e.g. upper screen, etc.) not included, to order separately: see 01-04-02-EN and 01-04-05-EN data sheets.



Characteristics	
Pressure vessel connection	Threaded 2 ½” - 8 UN male
Drain line connection	Threaded ¾” NPT, male
Brine line connection	Threaded ⅜” NPT, male
Distributor tube O. D. diameter	1,05” (= 27 mm)
Distributor tube length above pressure vessel	½” ± ½” (= 13 ± 13 mm)
Weight (valve + controller)	2,42 kg
Operating pressure	1,38 ÷ 8,27 bar
Water temperature	2°C ÷ 38°C

Model	Description	
278/764 TWIN	278/764 twin w/o interconnecting piping	

Autotrol Residential Valves Series 278 with 764 Controller for Multitank Systems



- for automatic and residential / commercial water softening systems;
- with electronic volumetric 764 controller (see 01-03-02-EN data sheet);
- for parallel systems;
- valve body in NSF listed Noryl plastic material;
- valve rubber compounded for cold water, NSF listed material;
- operating flow rate for each tank $K_v = 5,6$;
- backwash flow rate for each tank = 75,7 lpm @ Δp 1,72 bar;
- resin volume range for each tank = 45 ÷ 225 litres;
- with European transformer 12/230V – 50Hz for each valve;
- adapters and manifold kit not included, to order separately:
see 01-04-02-EN and 01-04-05-EN data sheets;
- accessories (e.g. upper screen, etc.) not included.



Characteristics	
Pressure vessel connection	Threaded 2 ½" - 8 UN male
Conessione linea di scarico	Threaded ¾" NPT, male
Brine line connection	Threaded ¾" NPT, male
Distributor tube O. D. diameter	1,05" (= 27 mm)
Distributor tube length above pressure vessel	½" ± ½" (= 13 ± 13 mm)
Weight (valve + controller)	2,42 kg
Operating pressure	1,38 ÷ 8,27 bar
Water temperature	2°C ÷ 38°C

Model	Description
278/764 SIN	278/764 single multi tank Volumetric

Autotrol Industrial Softening Magnum CV 1,5" Valves with Series Logix Controller



- for automatic and industrial water softening systems;
- valve body in NSF listed Noryl plastic material with 304 Stainless Steel tank adapter (for heavy applications, like iron removal using KMnO_4 or decarbonisation using HCl , the Noryl tank adapter is available on request);
- o-rings in EPDM material;
- operating flow rate $K_v = 17$;
- backwash flow rate = 337 lpm @ Δp 1,72 bar;
- resin volume range = 100 ÷ 700 litres;
- available with series LOGIX controller (see 01-03-02-EN data sheet):
 - 742 electronic chronometric programmable;
 - 762 electronic volumetric programmable;
- with European transformer 12/230V – 50/60 Hz;
- available with or without by-pass;
- adapters, manifold kit and accessories (e.g. upper screen, etc.) not included, to order separately: see 01-04-04-EN and 01-04-05-EN data sheets;
- brine tank refill system doesn't need a brine valve, but just an air-check;
- PVC 2" side mounting adapter available on demand (REF. CC084, see 01-04-04-EN data sheet).



Characteristics	
Pressure vessel connection	Threaded 4" - 8 UN male
Drain line connection	1,5" brass – NPT/BSPT male D50 CPVC to glue
Brine line connection	Threaded ¾" NPT male
Distributor tube O. D. diameter	1,5" (= 48,3 mm)
Pilot drain and auxiliary hydraulic out	¼" tube fitting
Distributor tube length above pressure vessel	16 ± 3 mm
Weight (valve + controller)	12,3 kg
Operating pressure	1,72 ÷ 6,90 bar
Water temperature	1°C ÷ 36°C

Model	Description	Note	
MG Cv 742-HWB	Electronic Chronometric Programmable	With hard water bypass	
MG Cv 742-NHB	Electronic Chronometric Programmable	Without bypass	
MG Cv 762-HWB	Electronic Volumetric Programmable	With hard water bypass	
MG Cv 762-NHB	Electronic Volumetric Programmable	Without bypass	

Autotrol Industrial Magnum CV 1,5" Valves for Filtration with Series Logix Controller



- for automatic and industrial water filtration systems;
- valve body in NSF listed Noryl plastic material with 304 Stainless Steel tank adapter (for heavy applications, like sea water, the Noryl tank adapter is available on request);
- o-rings in EPDM material;
- operating flow rate $K_v = 17$;
- backwash flow rate = 337 lpm @ Δp 1,72 bar;
- available with series LOGIX controller (see 01-03-02-EN data sheet):
 - 742 F electronic chronometric programmable;
 - 762 F electronic volumetric programmable;
- with European transformer 12/230V – 50/60 Hz;
- available with or without by-pass;
- adapters, manifold kit and accessories (e.g. upper screen, etc.) not included, to order separately: see 01-04-04-EN and 01-04-05-EN data sheets;
- PVC 2" side mounting adapter available on demand (REF. CC084, see 01-04-04-EN data sheet).



Characteristics	
Pressure vessel connection	Threaded 4" - 8 UN male
Drain line connection	1,5" brass – NPT/BSPT male D50 CPVC to glue
Brine line connection	Threaded 3/4" NPT male
Distributor tube O. D. diameter	1,5" (= 48,3 mm)
Pilot drain and auxiliary hydraulic out	1/4" tube fitting
Distributor tube length above pressure vessel	16 ± 3 mm
Weight (valve + controller)	12,3 kg
Operating pressure	1,72 ÷ 6,90 bar
Water temperature	1°C ÷ 36°C

Model	Description	Note	
MG Cv 742F-UWB	Electronic Chronometric Programmable Filtration	With raw water bypass	
MG Cv 742F-NUB	Electronic Chronometric Programmable Filtration	Without bypass	
MG Cv 762F-UWB	Electronic Volumetric Programmable Filtration	With raw water bypass	
MG Cv 762F-NUB	Electronic Volumetric Programmable Filtration	Without bypass	

Autotrol Industrial Softening Magnum IT 2” Valves with Series Logix Controller



- for automatic and industrial water softening systems;
- valve body in NSF listed Noryl plastic material with 304 Stainless Steel tank adapter (for heavy applications, like iron removal using $KMnO_4$ or decarbonisation using HCl, the Noryl tank adapter is available on request);
- o-rings in EPDM material;
- operating flow rate $K_v = 17$;
- backwash flow rate = 337 lpm @ Δp 1,72 bar;
- resin volume range = 100 ÷ 700 litres;
- available with series LOGIX controller (see 01-03-02-EN data sheet):
 - 742 electronic chronometric programmable;
 - 762 electronic volumetric programmable;
- with European transformer 12/230V – 50/60 Hz;
- available with or without by-pass;
- adapters, manifold kit and accessories (e.g. upper screen, etc.) not included, to order separately: see 01-04-04-EN and 01-04-05-EN data sheets;
- brine tank refill system doesn't need a brine valve, but just an air-check;
- PVC 2” side mounting adapter available on demand (REF. CC084, see 01-04-04-EN data sheet).



Characteristics	
Pressure vessel connection	Threaded 4” - 8 UN male
Drain line connection	1,5” brass – NPT/BSPT male D50 CPVC to glue
Brine line connection	Threaded ¾” NPT male
Distributor tube O. D. diameter	1,5 ” (= 48,3 mm)
Pilot drain and auxiliary hydraulic out	¼” tube fitting
Distributor tube length above pressure vessel	16 ± 3 mm
Weight (valve + controller)	12,3 kg
Operating pressure	1,72 ÷ 6,90 bar
Water temperature	1°C ÷ 36°C

Model	Description	Note	
MG IT 742- HWB	Electronic Chronometric Programmable	With hard water bypass	
MG IT 742- NHB	Electronic Chronometric Programmable	Without bypass	
MG IT 762- HWB	Electronic Volumetric Programmable	With hard water bypass	
MG IT 762- NHB	Electronic Volumetric Programmable	Without bypass	

Autotrol Industrial Magnum IT 2" Valves for Filtration with Series Logix Controller



- for automatic and industrial water filtration systems;
- valve body in NSF listed Noryl plastic material with 304 Stainless Steel tank adapter (for heavy applications, like sea water, the Noryl tank adapter is available on request);
- o-rings in EPDM material;
- operating flow rate $K_v = 17$;
- backwash flow rate = 337 lpm @ Δp 1,72 bar;
- available with series LOGIX controller (see 01-03-02-EN data sheet):
 - 742 F electronic chronometric programmable;
 - 762 F electronic volumetric programmable;
- with European transformer 12/230V – 50/60 Hz;
- available with or without by-pass;
- adapters, manifold kit and accessories (e.g. upper screen, etc.) not included, to order separately: see 01-04-04-EN and 01-04-05-EN data sheets;
- PVC 2" side mounting adapter available on demand (REF. CC084, see 01-04-04-EN data sheet).



Characteristics	
Pressure vessel connection	Threaded 4" - 8 UN male
Drain line connection	1,5" brass – NPT/BSPT male D50 CPVC to glue
Brine line connection	Threaded 3/4" NPT male
Distributor tube O. D. diameter	1,5" (= 48,3 mm)
Pilot drain and auxiliary hydraulic out	1/4" tube fitting
Distributor tube length above pressure vessel	16 ± 3 mm
Weight (valve + controller)	12,3 kg
Operating pressure	1,72 ÷ 6,90 bar
Water temperature	1°C ÷ 36°C

Model	Description	Note	
MG IT 742- UWB	Electronic Chronometric Programmable Filtration	With raw water bypass	
MG IT 742- NUB	Electronic Chronometric Programmable Filtration	Without bypass	
MG IT 762- UWB	Electronic Volumetric Programmable Filtration	With raw water bypass	
MG IT 762- NUB	Electronic Volumetric Programmable Filtration	Without bypass	

Industrial Duplex Systems with Autotrol Softening Magnum IT 2" Valves and 764 Controller



- for automatic and industrial water softening systems;
- for twin alternating and twin parallel systems;
- consisting of n.2 valves (one "main" and another one "secondary") with 764 electronic volumetric (see 01-03-02-EN data sheet);
- valve body in NSF listed Noryl plastic material with 304 Stainless Steel tank adapter (for heavy applications, like iron removal using KMnO₄ or decarbonisation using HCl, the Noryl tank adapter is available on request);
- o-rings in EPDM material;
- operating flow rate for each tank Kv = 17;
- backwash flow rate for each tank = 337 lpm @ Δp 1,72 bar;
- resin volume range for each tank = 100 ÷ 700 litres;
- with European transformer 12/230V – 50/60 Hz;
- available with or without by-pass;
- adapters, manifold kit and accessories (e.g. upper screen, etc.) not included, to order separately: see 01-04-04-EN and 01-04-05-EN data sheets;
- brine tank refill system doesn't need a brine valve, but just an air-check;
- PVC 2" side mounting adapter available on demand (REF. CC084, see 01-04-04-EN data sheet);
- interconnection not included.



Characteristics	
Pressure vessel connection	Threaded 4" - 8 UN male
Drain line connection	1,5" brass – NPT/BSPT male D50 CPVC to glue
Brine line connection	Threaded ¾" NPT male
Distributor tube O. D. diameter	1,5" (= 48,3 mm)
Pilot drain and auxiliary hydraulic out	¼" tube fitting
Distributor tube length above pressure vessel	16 ± 3 mm
Weight (valve + controller)	12,3 kg
Operating pressure	1,72 ÷ 6,90 bar
Water temperature	1°C ÷ 36°C

Model	Description	Note	
MG IT 764 TWIN	Twin Alternating/Parallel – Softening/Filtration	Without bypass	

Autotrol Industrial Softening Magnum IT 2" Valves with 764 Controller for Multitank Systems



- for automatic and industrial water softening systems;
- with electronic volumetric 764 controller (see 01-03-02-EN data sheet);
- for parallel systems;
- valve body in NSF listed Noryl plastic material with 304 Stainless Steel tank adapter (for heavy applications, like iron removal using $KMnO_4$ or decarbonisation using HCl, the Noryl tank adapter is available on request);
- o-rings in EPDM material;
- operating flow rate for each tank $K_v = 17$;
- backwash flow rate for each tank = 337 lpm @ Δp 1,72 bar;
- resin volume range for each tank = 100 ÷ 700 litres;
- with European transformer 12/230V – 50/60 Hz for each valve;
- available with or without by-pass;
- adapters, manifold kit and accessories (e.g. upper screen, etc.) not included, to order separately: see 01-04-04-EN and 01-04-05-EN data sheets;
- brine tank refill system doesn't need a brine valve, but just an air-check;
- PVC 2" side mounting adapter available on demand (REF. CC084, see 01-04-04-EN data sheet);
- interconnection not included.



Characteristics	
Pressure vessel connection	Threaded 4" - 8 UN male
Drain line connection	1,5" brass – NPT/BSPT male D50 CPVC to glue
Brine line connection	Threaded ¾" NPT male
Distributor tube O. D. diameter	1,5" (= 48,3 mm)
Pilot drain and auxiliary hydraulic out	¼" tube fitting
Distributor tube length above pressure vessel	16 ± 3 mm
Weight (valve + controller)	12,3 kg
Operating pressure	1,72 ÷ 6,90 bar
Water temperature	1°C ÷ 36°C

Model	Description	Note	
MG IT 764-NHB	Electronic Volumetric Multitank	Without bypass	

Autotrol Industrial Magnum IT 2" Valves for Filtration with 764 Controller with Multitank Systems



- for automatic and industrial water filtration systems;
- with electronic volumetric 764 F controller (see 01-03-02-EN data sheet);
- for parallel systems up to 6 tanks;
- valve body in NSF listed Noryl plastic material with 304 Stainless Steel tank adapter (for heavy applications, like sea water, the Noryl tank adapter is available on request);
- o-rings in EPDM material;
- operating flow rate for each tank $K_v = 17$;
- backwash flow rate for each tank = 337 lpm @ Δp 1,72 bar;
- with European transformer 12/230V – 50/60 Hz for each valve;
- available with or without by-pass;
- adapters, manifold kit and accessories (e.g. upper screen, etc.) not included, to order separately: see 01-04-04-EN and 01-04-05-EN data sheets;
- PVC 2" side mounting adapter available on demand (REF. CC084, see 01-04-04-EN data sheet);
- interconnection not included.



Characteristics	
Pressure vessel connection	Threaded 4" - 8 UN male
Drain line connection	1,5" brass – NPT/BSPT male D50 CPVC to glue
Brine line connection	Threaded 3/4" NPT male
Distributor tube O. D. diameter	1,5" (= 48,3 mm)
Pilot drain and auxiliary hydraulic out	1/4" tube fitting
Distributor tube length above pressure vessel	16 ± 3 mm
Weight (valve + controller)	12,3 kg
Operating pressure	1,72 ÷ 6,90 bar
Water temperature	1°C ÷ 36°C

Model	Description	Note	
MG IT 764F-NUB	Electronic Volumetric Multitank Filtration	Without bypass	

Series 400 Controllers for Autotrol Valves Series 255 - 263 – 268



440i



460tc / 460i



Controllers for softeners characteristics			
Characteristic	440i	460tc	460i
Controller type	Electromechanical	Electronic	Electronic
Regeneration mode	Chronometric: 7 or 6 days	Chronometric	Volumetric
Regeneration frequency	Daily	Daily	Daily
Regeneration cycle length	59' or 118'	59' or 118'	59' or 118'
Cycle length	Fixed not modifiable	Fixed not modifiable	Fixed not modifiable
Salt setting	Pounds of salt	Pounds of salt	Pounds of salt

Controllers for filtration characteristics		
Characteristic	440i	460tc
Controller type	Electromechanical	Electronic
Backwash mode	Chronometric: 7 or 6 days	Chronometric
Backwash frequency	Daily	Daily
Filter cycle length	Fixed not modifiable	Fixed not modifiable

Logix Controllers for Autotrol Valves

Series 255 – 263 – 268 – 273 – 278 – 293 – 298



Controllers for softeners characteristics

CHARACT.	740 C	760 C	742 C	762 C	764
Controller type	Electronic	Electronic	Electronic	Electronic	Electronic
Regeneration mode	Chronometric	Volumetric	Chronometric	Volumetric	Volumetric
Regeneration frequency	Fixed day or 0,5 ÷ 99 days calendar override	0,5 ÷ 99 days calendar override	Fixed day or 0,5 ÷ 99 days calendar override	0,5 ÷ 99 days calendar override	0,5 ÷ 99 days calendar override
Adjustable regeneration time	Yes	Yes	Yes	Yes	Yes
Cycle length	Computer calculated	Computer calculated	Fully programmable	Fully programmable	Fully programmable
Salt setting	3 options	3 options	Fully adjustable	Fully adjustable	Fully adjustable

Controllers for filtration characteristics

CHARACT.	740 F	760 F	742 F	762 F	764 F
Controller type	Electronic	Electronic	Electronic	Electronic	Electronic
Backwash mode	Chronometric	Volumetric	Chronometric	Volumetric	Volumetric
Backwash frequency	Fixed day or 0,5 ÷ 99 days calendar override	0,5 ÷ 99 days calendar override	Fixed day or 0,5 ÷ 99 days calendar override	0,5 ÷ 99 days calendar override	0,5 ÷ 99 days calendar override
Adjustable cycle time	Programmable backwash time	Programmable backwash time	Fully programmable	Fully programmable	Fully programmable
Filter cycle length	Computer calculated	Computer calculated	Fully adjustable	Fully adjustable	Fully adjustable



256 bypass kits

- with gaskets, brass adapters, screws and nuts.

REF.	IN/OUT CONNECTION	DRAIN LINE	
AV028	3/4"	1/2"	
AV029	1"	1/2"	

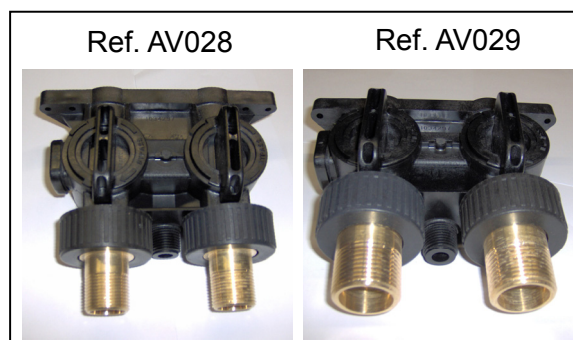

Female manifold kits

- with o-rings, screws and nuts.

REF.	IN/OUT CONNECTION	DRAIN LINE	MATERIAL	
AV013	3/4"	1/2"	NORYL	
AV010	3/4"	3/8"	BRASS	
AV011	1"	1/2"	BRASS	



Female mixing manifold kits

- with o-rings, screws and nuts.

REF.	IN/OUT CONNECTION	DRAIN LINE	MATERIAL	
AV007	3/4"	3/8"	BRASS	
AV012	1"	1/2"	BRASS	



Autotrol Valves Series 255 Accessories



Male manifold kits

- in plastic material Noryl;
- with o-rings, screws and nuts.

REF.	CONNECTIONS IN/OUT	DRAIN LINE	OPTION	
AV001	3/4"	3/4"	WITH TURBINE	
AV001A	3/4"	3/4"	WITHOUT TURBINE	
AV022	1"	1/2"	WITH TURBINE	
AV022A	1"	1/2"	WITHOUT TURBINE	

Ref. AV022



Slim cover for valve 255 Logix

- in plastic material.

REF.	
AW145	

Ref. AW145



D. 32 interconnection kit for 255/764twin residential duplex systems

- special manifold for AUTOTROL 255 valves included;
- for twin alternating and twin parallel systems;
- consisting of:

QUANTITY	DESCRIPTION
2	Adapter PVC-U D = 32 mm - 1"
2	Tee connection PVC-U D = 32 mm
4	Elbow PVC-U D = 32 mm D1 = 25 mm
4	Tube PVC-U D = 32 mm
2	Elbow D = 32 mm
2	Coupling sleeve D = 32 mm
2	Manifold kit with adapter D. 32 to glue
2	256 by-pass with o-rings, screws and nuts

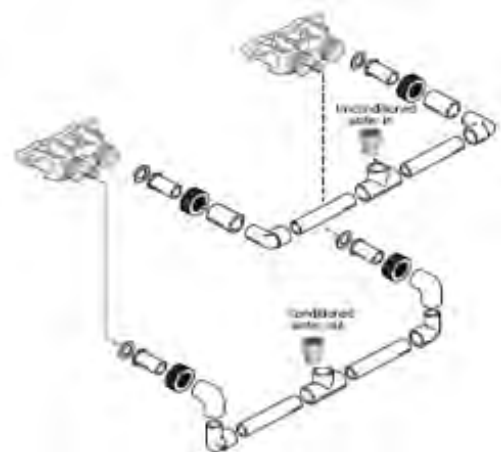

REF.

AV119



1265 bypass Kits

- special manifold for AUTOTROL valves series 263, 268 and 278;
- with gaskets, brass adapters and nuts.

REF.	IN/OUT CONNECTIONS	
AV039	1"	
AV040	1 1/4"	

Ref. AV039



Ref. AV040

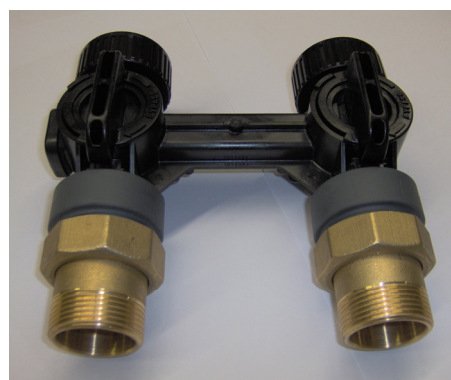

Manifold Kits

- special manifold for AUTOTROL valves series 263, 268 and 278;
- with 2 gaskets, 2 adapters and 2 nuts.

REF.	IN/OUT CONNECTION	MATERIAL ADAPTERS	
AV030B	3/4"	BRASS	
AV031B	1"	BRASS	
AV032	D.32	PVC	
AV038	1 1/4"	BRASS	

Ref. AV031B





D. 32 interconnection kit for 278/764twin residential duplex systems

- special manifold for AUTOTROL 278 valves included;
- for twin alternating and twin parallel systems;
- with IN/OUT connection D.32;
- consisting of:

Q.TY	DESCRIPTION
2	Adapter PVC-U D = 32mm - 1"
2	Tee connection PVC-U D = 32 mm
4	Elbow PVC-U D = 32 mm D1 = 25 mm
4	Tube PVC-U D = 32 mm
2	Elbow D = 32 mm
2	Coupling sleeve D = 32 mm
2	Manifold kit with adapter D. 32 to glue
2	1265 by-pass with o-rings, screws and nuts

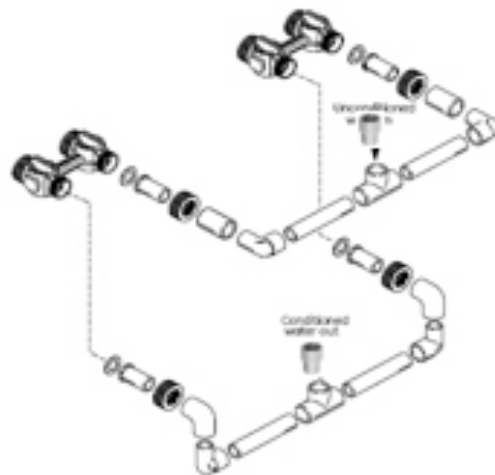

REF.	
AV128	

D. 40 interconnection kit for 278/764twin residential duplex systems

- special manifold for AUTOTROL 278 valves included;
- for twin alternating and twin parallel systems;
- with IN/OUT connection D.40;
- consisting of:

Q.TY	DESCRIPTION
2	Adapter PVC-U D = 40mm - 1 1/4"
2	Tee connection PVC-U D = 40 mm
4	Reducing socket PVC-U D = 40 mm D2 = 32 mm
4	Elbow PVC-U D = 32 mm D1 = 25 mm
4	Tube PVC-U D = 32 mm
2	Elbow D = 32 mm
2	Coupling sleeve D = 32 mm
2	Manifold kit with adapter D. 32 to glue
2	1265 by-pass with o-rings, screws and nuts

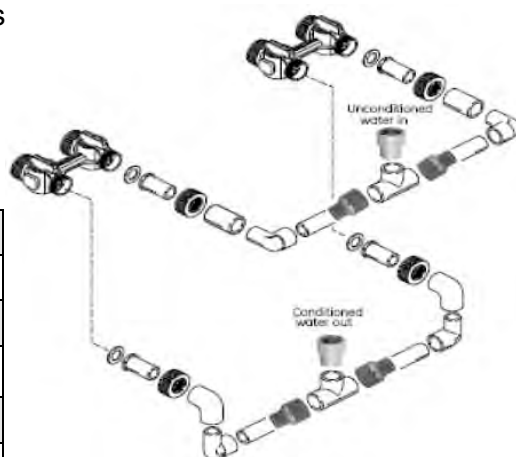

REF.	
AV129	



Magnum side mounting adapters

- in PVC material

REF.	CONNECTIONS	
CC084	2" BSPT Female	
CC084A	D.63 Male to glue	

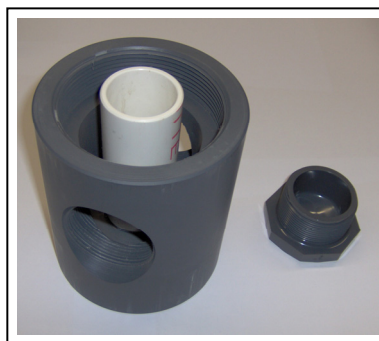

Manifold kits

- with 3 nuts, 3 gaskets and 3 adapters.

REF.	IN/OUT CONNECTION	MATERIAL ADAPTER	FOR AUTOTROL VALVE	
CC080	1 1/2" BSPT	STAINLESS STEEL	MAGNUM CV 1,5" SERIES	
CC081	D.50	PVC	MAGNUM CV 1,5" SERIES	
CC082	2" BSPT	STAINLESS STEEL	MAGNUM IT 2" SERIES	
CC083	D.63	PVC	MAGNUM IT 2" SERIES	

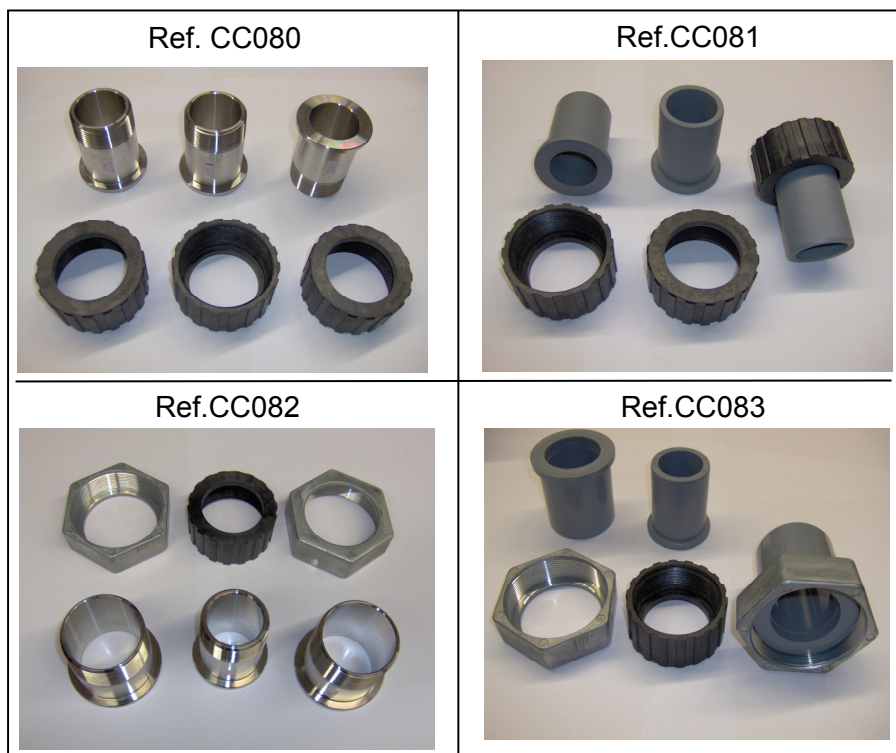



D.25 NPT 3/4" Pipe Union



REF.	
CC085	

- Suitable for brine line connection of the Magnum valves, alone or in coupling with a bonding hose connection (REF. CC086);
 - In PVC-U.
-

D.25 Drain Fitting to glue

- Suitable for brine line connection of the Magnum valves, in coupling with D.25 NPT 3/4" pipe union (REF. CC085);
- In PVC-U.



REF.	
CC086	



Blending kit for Autotrol valves

- kit of nut and screw to install on 255 and 268 valves for blending of hard and softened water;
- insert the nut into the blending valve orifice located near the bypass flapper (fig.1). Insert the screw through the top plate and the nut, and the screw until it touch the bypass flapper (fig.2);
- tightening the screw will force the bypass flapper open witch will blend hard water into the softened water supply (fig. 3). Loosening the screw will allow the bypass flapper to close reducing the blending;
- test the water and adjust the screw until the desired hardness level is reached.

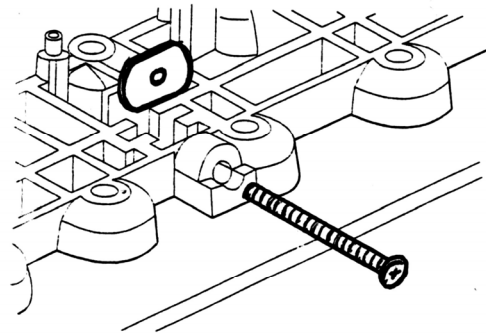

Fig. 1

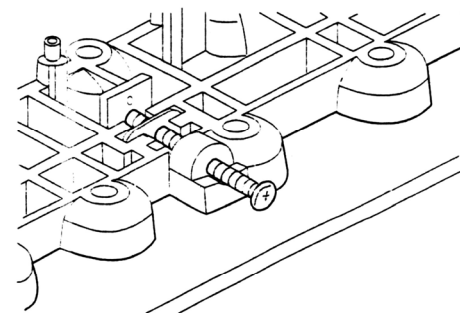

Fig. 2

REF.	DESCRIPTION	
AV037	Kit for 255-268-278 valves	
AV185	Kit for 366-368 valves	

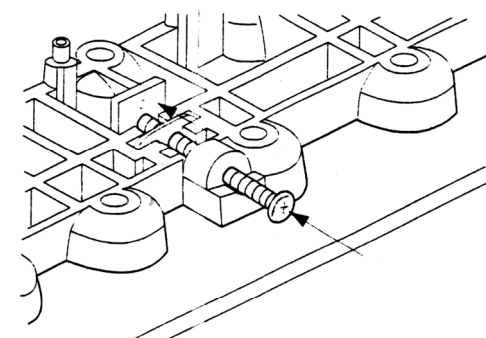

Fig. 3



Twist lock upper screens

- in ABS;
- max diameter 60 mm, length 64 mm;
- slots 0,3 mm.

REF.	FOR TUBE (inch)	FOR AUTOTROL VALVE	
AV070	13/16"	255	
AV071	1,05"	255, 263, 268	



Upper screen

- in ABS;
- max diameter 60 mm, length 64 mm;
- slots 0,3 mm.

REF.	FOR TUBE (inch)	
AV072	13/16"	
AV073	1,05"	



Upper screens to glue

- in ABS;
- diameter 88 mm;
- slots 0,3 mm.

REF.	LENGTH (mm)	FOR TUBE (mm)	FOR AUTOTROL VALVE	
CF010	98	41,8 (1 1/4")	180 old model	
CF013	98	48,3	180 new model	
CC050	150	48,3	Magnum	
PV407	150	41,8 (1 1/4")	Adapter 4" PV402	





Fittings for valves

- Jaco Style elbow fittings for $\frac{3}{8}$ " tubing;
- material PP.

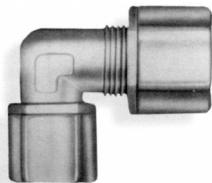

REF.	THREADED CONNECTION (inch)	FOR AUTOTROL VALVE	
AV150	$\frac{1}{4}$ " F	255	
AV154	$\frac{3}{8}$ " F	268 366 – 368	

Fittings for valves

- Jaco Style straight fittings for $\frac{3}{8}$ " tubing;
- material PP.

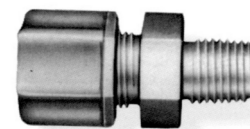

REF.	THREADED CONNECTION (inch)	
AV161	$\frac{1}{8}$ " M	
AV152	$\frac{1}{4}$ " M	
AV153	$\frac{3}{8}$ " M	

- Jaco Style elbow fittings for $\frac{3}{8}$ " tubing;
- material PP.

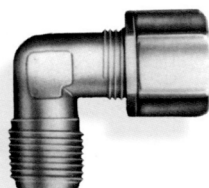

REF.	THREADED CONNECTION (inch)	FOR AUTOTROL VALVE	
AV151	$\frac{1}{4}$ " M	155	
AV159	$\frac{3}{8}$ " M	-	

- Jaco Style bulkhead union for $\frac{3}{8}$ " tubing;
- material PP.

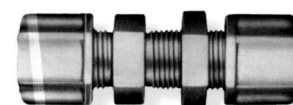

REF.	
AV156	

- Jaco Style union elbow for $\frac{3}{8}$ " tubing;
- material PP.

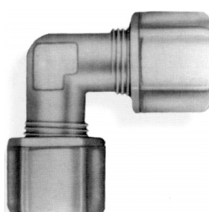

REF.	
AV155	

- Jaco Style union TEE for $\frac{3}{8}$ " tubing;
- material PP.



REF.	
AV158	



Barbed drain fittings – overflow

Straight drain fittings

- suitable for flexible hose 12,7 mm internal diameter;
- material nylon.

REF.	CONNECTION	
AV170	3/8" M	
AV171	1/2" M	
AV169	1/2" F	

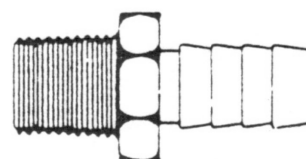

Elbowed drain fittings

- suitable for flexible hose 12,7 mm internal diameter;
- material nylon / polyethylene.

REF.	CONNECTION	
AV172	3/8" M	
AV173	1/2" M	
AV174	1/2" F	
AV175	3/4" F	

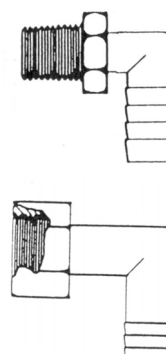

Overflow elbows with nut

- material nylon.

REF.	THREADED CONNECTION	FOR HOSE INT. Ø (MM)	
AV180	3/8"	12,7	
AV181	1/2"	15,5	

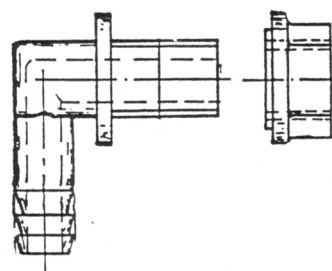



Pvc tubes to glue

- for lower diffusers and lower lateral systems;
- to glue;
- in PVC.

REF.	DIAMETER (inch)	DIAMETER (mm)	LENGTH (mm)	
AV083	1 ³ / ₁₆ "	20,6	890	
AV084	1 ³ / ₁₆ "	20,6	1400	
AV087	1,05"	26,7	1830	
CF012	1 1/4"	41,8	2000	
CC052	1 1/2"	48,3	2000	



Diffusers with tube

- 1,05" hi-flow lower diffuser;
- PVC tube included;
- slots 0,3 mm.

REF.	TUBE LENGTH (inch)	
AV116M	17"	
AV117M	35"	
AV103M	55"	
AV104M	72"	





Lower diffusors to glue

- lower diffusors in ABS;
- max diameter 60 mm;
- slots 0,3 mm;
- connection to glue.

REF.	FOR TUBE (inch)	LENGTH (mm)	FLOW (lpm) Δp 30 mbar	
AV098	1 $\frac{3}{16}$ "	70	24	
AV098A	1,05"	80	32	
AV097	1,05"	90 high flow	40	



Cylindrical lower diffusors

- cylindrical lower diffuser in ABS, diameter 88 mm;
- slots 0,3 mm;
- connection to glue.

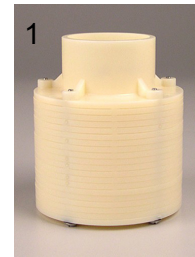

ITEM	REF.	LENGTH (mm)	DIFFUSOR LENGTH (mm)	FOR AUTOTROL VALVE	
1	PV315	72	26,7 (1,05")	PERFORMA	
1	CF011	98	41,8 (1 $\frac{1}{4}$ ")	180 old model – PV402	
1	CF014	98	48,3	180 new model	
2	CC051	150	48,3	Magnum	

Segmented lower diffusors

- segmented lower diffuser in ABS;
- diameter 66 mm;
- length 102 mm;
- slots 0,3 mm;
- to glue on tube 1,05";
- flow = 50 lpm @ Δp 30 mbar.

REF.	
AV099A	





Lower lateral systems for top mounted valves

- For top mounted valves;
- ABS material;
- With 8 laterals (**threaded connection**) slots 0,3 mm;
- Hub connection to glue.



REF.	USEFUL FOR VESSEL (inch)	HUB CONNECT FOR TUBE (mm)	FOR AUTOTROL VALVE	
PV316	14" - 16"	26,7 (1,05")	PERFORMA	
PV317	18" - 21" - 24"	26,7 (1,05")	PERFORMA	
PV318	14" - 16"	41,8 (1 ¼")	PV402	
PV319	18" - 21" - 24"	41,8 (1 ¼")	PV402	
PV320	14" - 16"	48,3 (1,90")	MAGNUM	
PV321	18" - 21" - 24"	48,3 (1,90")	MAGNUM	
PV322	30"	48,3 (1,90")	MAGNUM	
PV323	36"	48,3 (1,90")	MAGNUM	

Lower lateral systems for top mounted valves

- For top mounted valves;
- ABS material;
- With 6 **twist lock** laterals, slots 0,25 mm;
- Hub connection to glue.

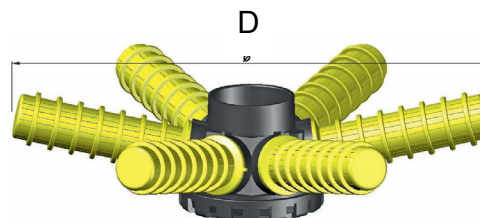

REF.	USEFUL FOR VESSEL (inch)	HUB CONNECT FOR TUBE (mm)	DIAMETER D (mm)	FOR AUTOTROL VALVE	
PV316B	14" - 16"	26,7 (1,05")	260	PERFORMA	
PV317B	18" - 21" - 24"	26,7 (1,05")	373	PERFORMA	
PV318B	14" - 16"	41,8 (1 ¼")	260	PV402	
PV319B	18" - 21" - 24"	41,8 (1 ¼")	373	PV402	
PV320B	14" - 16"	48,3 (1,90")	260	MAGNUM	
PV321B	18" - 21" - 24"	48,3 (1,90")	373	MAGNUM	
PV322B	30"	48,3 (1,90")	563	MAGNUM	
PV323B	36"	48,3 (1,90")	705	MAGNUM	
PV320B50	14" - 16"	50 (2")	260		
PV321B50	18" - 21" - 24"	50 (2")	373		
PV322B50	30"	50 (2")	563		
PV323B50	36"	50 (2")	705		



Diffusor for brine draw

- connection for rigid or flexible tube $\frac{3}{8}$ ".



REF.	
AV118	

Mesh type screen with tube

- mesh type screen for brine complete with $\frac{3}{8}$ " PVC tube length 42".



REF.	
AV090M	

Mesh type screen for brine

- for $\frac{3}{8}$ " tube to glue.

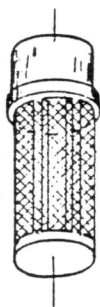

REF.	
AV075	

Polyethylene flexible tube

- flexible tube $\frac{3}{8}$ " (= 9,52 mm) diameter;
- transparent;
- hanks of 30 m.

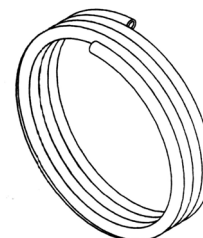

REF.	
AV140	



J-tube air-check with tube

- J-tube with air-check, complete with PVC tube.

REF.	TUBE DIAMETER (inch)	LENGTH (mm)	
AV093M	$\frac{3}{8}$ "	1060	
CC064M	$\frac{3}{4}$ "	1200	



Model 464

- model 464 Standard version (for no timed refill controls) and High Flow (for timed refill controls);
- connection for 3/8" tubing;
- length tube 42" (1060 mm);
- length float rod 600 mm;
- brine draw rate 3,8 l/min @ 152 mm Hg vacuum;
- max operating pressure 8,5 bar @ 40°C;
- brine well diameter 90 mm min.

REF.	MODEL	Refill flow rate (l/min) @ 3,5 bar	
AV096	464 Standard	1,3	
AV125	464 High Flow	3,8	

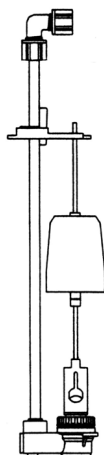

Model 484

- complete with 3/4" tube length 1200 mm;
- length float rod 915 mm;
- refill flow rate 15 l/min @ 3,5 bar;
- brine draw rate 38 l/min @ 66 mm Hg vacuum;
- max operating pressure 8,5 bar @ 40°C;
- brine well diameter 130 mm.

REF.	
CC059	

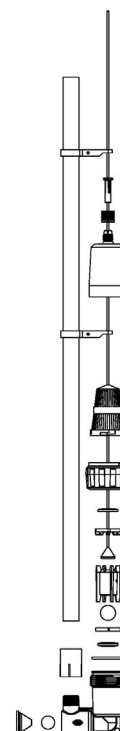

Model 2310

- length float rod 774 mm;
- refill flow rate 4,5 l/min;
- brine draw rate 2,1 l/min;
- max operating pressure 8,6 bar @ 40°C;
- brine well diameter 100 mm;
- without air check.

REF.	
F060067-03	

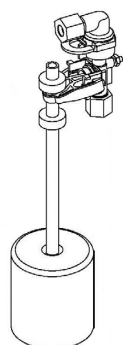



Heads for tank

- PVC heads for tank complete with NBR o-ring;
- max operating pressure 8 bar;
- max operating temperature 25°C;
- REF. PV400 and REF. PV401 are to use with upper screen REF. AV073 (see 01-04-05.02-EN data sheet) and with lower diffusors on catalogue (see 01-04-05.06-EN data sheet);
- REF. PV402 is to use with upper screen REF. PV407 (see 01-04-05.02-EN data sheet) and with lower diffusor REF. CF011 (see 01-04-05.06-EN data sheet).

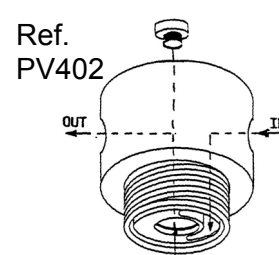
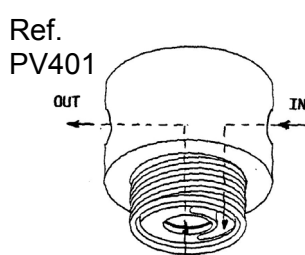
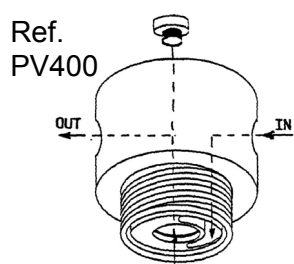

REF.	IN / OUT CONNECTION	OPTION PLUG	RISER TUBE DIAMETER	MAX FLOW RATE SUGGESTED	FIT THREADED TANKS
PV400	3/4" GAS	1/2" on outlet	1,05"	2,5 m ³ /h	2 1/2" – 8NPSM
PV401	3/4" GAS	no plug	1,05"	2,5 m ³ /h	2 1/2" – 8NPSM
PV402	1 1/4" GAS	1/2" on outlet	1 1/4"	6,0 m ³ /h	4" – 8UN

- PP molded heads for tank with connection threaded 2 1/2" – 8NPSM;
- complete with NBR o-ring;
- without plug;
- max operating pressure 8 bar;
- max operating temperature 45°C; it is to use with upper screen REF. AV070 (see 01-04-05.02-EN data sheet) and with lower diffusor REF. AV098 (see 01-04-05.06-EN data sheet).



REF.	IN / OUT CONNECTION	RISER TUBE DIAMETER	MAX SUGGESTED FLOW RATE
PV409	3/4" NPT	13/16"	2,5 m ³ /h



For our Ref. PV410 see Multi-way Manual Valves, 01-11-01-EN data sheet.

Conductivity Meter Resilight

- positive, reliable and economical method of monitoring water quality via conductivity;
- bright green/red visual output easy to read:
 - Green: conductivity below the threshold value;
 - Red: conductivity above the threshold value;
 - set point conductivity adjustable from 1,5 to 200 microsiemens;
- probe with threaded $\frac{3}{8}$ " connection, probe constant K=5;
- with reduction in PVC M/F $\frac{1}{2}$ " x $\frac{3}{8}$ ";
- complete with transformer 230/5V - 50 Hz and 1,5 m cable;
- for installation on piping at system outlet, or directly on the heads REF. PV400 and REF. PV402 (see 01-04-05.10-EN data sheet).

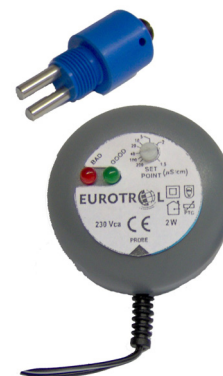

ATTENTION: for greatest accuracy it is required that the water be flowing on probe.

REF.	
PV425	

Chlorgen Chlorin Generator

- positive, reliable and economical method of chlorine generation;
- n.1 Titanium Probe for chlorine generation, n.1 TEE $\frac{3}{8}$ " connection and n.2 Jaco straight fitting for $\frac{3}{8}$ " x $\frac{3}{8}$ " tube included;
- bright green/yellow visual output easy to read:
 - Green: the system is on;
 - Yellow: the system is working in disinfection;
- with time generation adjust;
- 230V - 50 Hz power supply and 1,8 m cable.



REF.	
AX210	



Test kit for hardness

- kit for hardness testing with indicator and titrant complete with test tube;
- definition 0,5 °F;
- number of tests 400°F;
- available No 6 blister of indicator 15 ml (REF. AV203) and No 6 blister of titrant 25 ml (REF. AV204).

Ref. AV200

REF.	
AV200	
AV203	
AV204	



- kit for hardness testing with single reagent packaged in blister, with test tube;
- available for definition with French (REF. AV202) or German (REF. AV207) degrees.

Ref. AV202

REF.	DEFINITION	NUMBER OF TESTS	
AV202	1°F	700°F	
AV207	1°D	600°D	



- kit for hardness testing with single reagent packaged in blister, with test tube;
- available for definition with French (REF. AV201) or German (REF. AV206) degrees.

Ref. AV201

REF.	DEFINITION	NUMBER OF TESTS	
AV201	1°F	350°F	
AV206	1°D	300°D	





Chlorine generator suitable for valve 255 and Performa 268 with Logix 740/760 and 742/762 controller

- Simple, reliable and cheap disinfection device;
- Delivery includes n.1 electrode and n.1 connection cable;
- Logix 740/760 and 742/762 controllers provide to make a low chlorine level in order to sanitize resin bed during regeneration;
- Logix controller has a light check salt that indicates to end user when salt has to be added into brine tank;
- Potassium chloride or sodium chloride can be used.

REF.	
AX040	

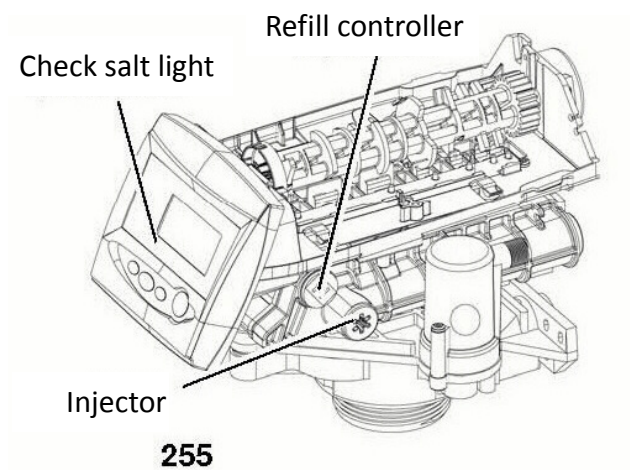

Chlorine generator connection

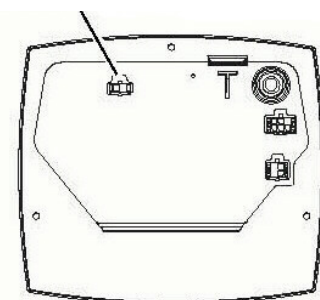

Logix controller - Rear

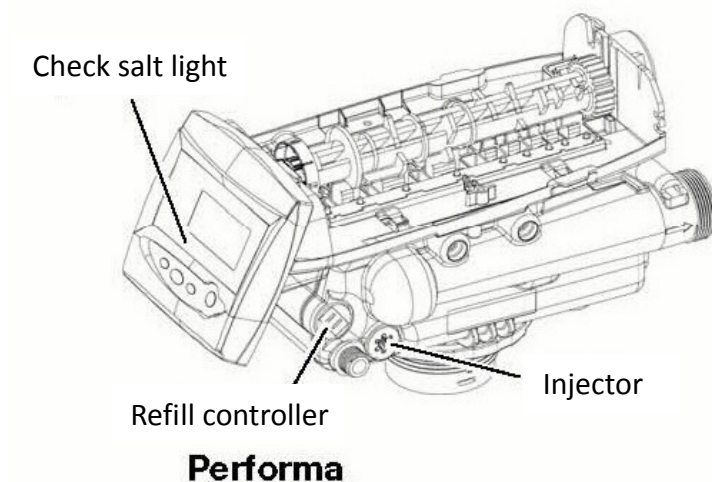



TOTAL CHLORINE KIT

- Color comparison kit for Chlorine reaction;
- Ideal for water with low content of organics, like drink water.

REF.	MODEL	RANGE (ppm Cl ₂)	TEST QUANTITY
AV205	O-TOL	0,10 - 0,25 - 0,50 - 0,75 - 1,0 - 2,0	75

CHLORINE DPD KIT

- Color comparison kit for Chlorine reaction;
- This kit measures the free chlorine and the total chlorine. The difference is given by the combined chlorine (for water with high total organic carbon);
- IPT kits are ideal for few analyzes with discrete precision. For higher precision, we suggest the HYDROCHECK DPD (ideal for waste water, purified drinking water and swimming pool).

REF.	MODEL	RANGE		TEST QUANTITY
		SAMPLE	(ppm Cl ₂)	
AV208	IPT DPD	5 ml	0,1 - 0,2 - 0,3 - 0,4 - 0,5 - 0,75 - 1,0 - 1,5	150
AV220	HYDROCHECK DPD	I	0,1 - 0,2 - 0,3 - 0,4 - 0,5 - 0,75 - 1,0 - 1,5	350
		II	0,025 - 0,050 - 0,075	

AMMONIA KIT

- Color comparison kit for Ammonia reaction;
- IPT kits are ideal for few analyzes with discrete precision. For higher precision, we suggest the HYDROCHECK.

REF.	MODEL	RANGE (ppm NH ₃)	TEST QUANTITY
AV209	IPT	0,25 - 0,50 - 0,75 - 1,0 - 2,0 - 8,0	200
AV221	HYDROCHECK	0,0 - 0,10 - 0,25 - 0,5 - 1,0 - 2,0 - 4,0	180



IRON KIT

- Color comparison kit for Iron reaction;
- IPT kits are ideal for few analyzes with discrete precision. For higher precision, we suggest the HYDROCHECK HIGH.

REF.	MODEL	RANGE		TEST QUANTITY	
		SAMPLE	(ppm Fe)		
AV210	IPT	5 ml	0,25 - 0,50 - 1,0 - 2,0 - 5,0 - 7,5 - 10 - 15	100	
		20 ml	0,05 - 0,10 - 0,15 - 0,20		
AV222	HYDROCHECK HIGH	I	0,25 - 0,50 - 1,0 - 2,0 - 5,0 - 7,5 - 10 - 15	400	
		II	0,05 - 0,10 - 0,15 - 0,20		

MANGANESE KIT

- Color comparison kit for Manganese reaction;
- IPT kits are ideal for few analyzes with discrete precision. For higher precision, we suggest the HYDROCHECK.

REF.	MODEL	RANGE		TEST QUANTITY	
		SAMPLE	(ppm Mn)		
AV211	IPT	5 ml	0,1 - 0,2 - 0,25 - 0,5 - 0,75 - 1,0 - 1,25 - 1,5	70	
AV223	HYDROCHECK	I	0,1 - 0,2 - 0,25 - 0,5 - 0,75 - 1,0 - 1,25 - 1,5	130	
		II	0,025 - 0,050 - 0,100		



NITRATE KIT

- Color comparison kit for Nitrate reaction;
- IPT kits are ideal for few analyzes with discrete precision. For higher precision, we suggest the HYDROCHECK (ideal for waste water, superficial water and drinking water).

REF.	MODEL	RANGE (ppm NO ₃)	TEST QUANTITY	
AV212	IPT	10 - 20 - 40 - 60 - 80 - 100 - 120 - 140	50	
AV224	HYDROCHECK	5 - 10 - 20 - 40 - 60 - 80 - 100 - 120 - 140	100	

PH KIT

- Color comparison kit for pH;
- IPT kits are ideal for few analyzes with discrete precision. For higher precision, we suggest pH meters.

REF.	MODEL	RANGE (pH)	TEST QUANTITY	
AV213	IPT	1-2-3-4-5-5,5-6-6,5-7-7,5-8-8,5-9-9,5-10-11	200	

SULPHATE KIT

- Color comparison kit for Sulphate by turbidimetric method.

REF.	MODEL	RANGE (ppm SO ₄)	TEST QUANTITY	
AV214	IPT	50 - 75 - 100 - 150 - 200 - 250 - 300 - 400	70	

F65 Runxin Residential Down Flow Valves



- Electronic programmable valve, suitable for automatic and residential water softening systems;
- Valve body in NSF listed Noryl plastic material;
- Operating system based on two high design ceramic discs;
- Regeneration DF;
- Operating flow rate Kv = 1,08;
- Backwash flow rate Kv = 0,50;
- Resin volume range = 5 ÷ 40 liters;
- Available in chronometric or volumetric versions;
- With White Injector mounted (Pink, Yellow and Blue Injectors included), European transformer 12/230V – 50Hz, upper screen, n.1 Base Seal O-ring, n.1 Drain Hose Connector, n.1 Brine Tube Hose Connector, n.1 Tube Bushing and n.1 Brine Line Flow Control);
- Others injectors and accessories not included, to order separately (please, see the data sheet 01-06-01-EN).



REF.
RF65B1



REF.
RF65D1

Characteristics	
Tank size	6" ÷ 10"
In / Out connections	Threaded 3/4" female (male optional included)
Pressure vessel connection	Threaded 2 1/2" - 8 UN male
Drain line connection	Threaded 1/2" male
Brine line connection	Threaded 3/8" BSPT male
Distributor tube O. D. diameter	1,05" (= 27 mm)
Distributor tube length above pressure vessel	0 ± 2 mm
Weight (valve + controller)	1,66 kg
Operating pressure	1,5 ÷ 6,0 bar
Water temperature	5°C ÷ 50°C

REF.	DESCRIPTION
RF65B1	Electronic Chronometric Softening Valve (LED)
RF65D1 (*)	Electronic Chronometric Softening Valve (LCD)
RF65D1/F70B (*)	Electronic Chronometric Softening Valve (LCD) with By-pass
RF65D3/F70BL (*)	Electronic Volumetric Softening Valve (LCD) with By-pass with Turbine

SPECIFIC ACCESSORIES

(*) currently not available in stock.

REF.	DESCRIPTION
RF70B	By-pass for RF65 and RF69 Valves
RF70BL	By-pass with Turbine for RF65 and RF69 Valves

SPARE PARTS

REF.	DESCRIPTION
RF09967	European Power Adapter
RFP9999	Upper Screen 3/4" Bajonet

F79B-LCD Runxin Residential Volumetric Valve



- Electronic volumetric programmable valve, suitable for automatic and residential water softening systems;
- Valve body in NSF listed Noryl plastic material;
- Operating system based on two high design ceramic discs;
- Regeneration DF or UF;
- Operating flow rate $K_v = 1,14$; Backwash flow rate $K_v = 0,5$;
- Resin volume range = $5 \div 40$ liters;
- With Pink Injector mounted (Yellow, Blue and White Injectors included), European transformer 12/230V – 50Hz, upper screen, n.1 Base Seal O-ring, n.1 Drain Hose Connector, n.1 Brine Tube Hose Connector, n.1 Tube Bushing and n.1 red Brine Line Flow Control), Meter and Bypass Adjusting Bolt;
- Others injectors and accessories not included, to order separately (please, see the data sheet 01-06-01-EN).



REF.
RF79B-LCD

Characteristics	
Tank size	6" ÷ 10"
In / Out connections	Threaded 3/4" male
Pressure vessel connection	Threaded 2 1/2" - 8 UN male
Drain line connection	Threaded 1/2" male
Brine line connection	Threaded 3/8" BSPT male
Distributor tube O. D. diameter	1,05" (= 27 mm)
Distributor tube length above pressure vessel	0 ± 2 mm
Weight (valve + controller)	2,25 kg
Operating pressure	1,5 ÷ 6,0 bar
Water temperature	5°C ÷ 50°C

REF.	DESCRIPTION
RF79B-LCD	Electronic Volumetric Softening Valve

SPECIFIC ACCESSORIES

REF.	DESCRIPTION
RF70D	By-pass for RF79B-LCD Valve

SPARE PARTS

REF.	DESCRIPTION
RF09962	O-R CONNECTOR 3/4" FOR FLOW METER
RF09963	CONNECTOR 3/4" FLOW METER
RF09964	ELECTRONIC CONTROL BOARD
RF09965	ELECTRONIC POSITIONING BOARD
RF09966	ELECTRONIC BOARD FOR DISPLAY
RF09967	EUROPEAN POWER ADAPTER
RF09968	TURBINE FLOW METER
RF09969	SEMI-TRANSPARENT COVER
RF09970	PIPE CONNECTIONS 3/4"
RFP9999	Upper Screen 3/4" Bajonet

F69 Runxin Residential Up Flow Softening Valves



- Electronic programmable valve, suitable for residential water softening systems;
- Valve body in NSF listed Noryl plastic material;
- Operating system based on two high design ceramic discs;
- Regeneration UF;
- Operating flow rate Kv = 1,08;
- Backwash flow rate Kv = 0,5;
- Resin volume range = 5 ÷ 40 liters;
- Available in chronometric or volumetric versions;
- F69C Valve is with Brown Injector mounted;
- F69P Valves are with Pink Injector mounted (Yellow, Blue and White Injectors included);
- European transformer 12/230V – 50Hz, upper screen, n.1 Base Seal O-ring, n.1 Drain Hose Connector, n.1 Brine Tube Hose Connector, n.1 Tube Bushing and n.1 Brine Line Flow Control);
- Others injectors and accessories not included, to order separately (please, see the data sheet 01-06-01-EN).



REF.
RF69P3Y

Characteristics	
Tank size	6" ÷ 10"
In / Out connections	Threaded 3/4" female (male optional included)
Pressure vessel connection	Threaded 2 1/2" - 8 UN male
Drain line connection	Threaded 1/2" male
Brine line connection	Threaded 3/8" BSPT male
Distributor tube O. D. diameter	1,05" (= 27 mm)
Distributor tube length above pressure vessel	0 ± 2 mm
Weight (valve + controller)	2,04 kg
Operating pressure	1,5 ÷ 6,0 bar
Water temperature	5°C ÷ 50°C

REF.	DESCRIPTION
RF69C	Electronic Chronometric Semi-Automatic Valve
RF69P1Y	Electronic Chronometric Valve (Indicator)
RF69P3Y	Electronic Volumetric Valve (Indicator)
RF69P3Y/F70BL (*)	Electronic Volumetric Valve (Indicator) with By-pass with Turbine

(*) currently not available in stock.

SPECIFIC ACCESSORIES

REF.	DESCRIPTION
RF70B	By-pass for RF65 and RF69 Valves
RF70BL	By-pass with Turbine for RF65 and RF69 Valves
RF09960	USB Programmer for RF65 and RF69 Valves

SPARE PARTS

REF.	DESCRIPTION
RF09967	European Power Adapter
RFP9999	Upper Screen 3/4" Bajonet

F73A Runxin Residential Volumetric Valve on a Duplex Tanks



- Electronic volumetric programmable valve, suitable for automatic and residential water softening systems;
- Valve body in NSF listed Noryl plastic material;
- Operating system based on two high design ceramic discs;
- Regeneration DF or UF;
- Operating flow rate Kv = 2,33;
- Backwash flow rate Kv = 0,88;
- Resin volume range = 45 ÷ 100 liters;
- With Red Injector mounted (Black Injector included), European transformer 12/230V – 50Hz, upper screen, n.1 Base Seal O-ring, n.1 Drain Hose Connector, n.1 Brine Tube Hose Connector, n.1 Tube Bushing, n.1 Brine Line Flow Control, Meter and Bypass Adjusting Bolt;
- Others injectors and accessories not included, to order separately (please, see the data sheet 01-06-01-EN).

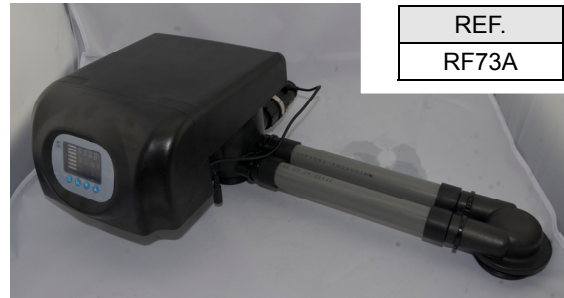

REF.
RF73A

Characteristics	
Tank size	10" ÷ 14"
In / Out connections	Threaded 1" male
Pressure vessel connection	Threaded 2 ½" - 8 UN male
Drain line connection	Threaded ¾" male
Brine line connection	Threaded ⅜" BSPT male
Distributor tube O. D. diameter	1,05" (= 27 mm)
Distributor tube length above pressure vessel	0 ± 2 mm
Weight (valve + controller)	4,75 kg
Operating pressure	1,5 ÷ 6,0 bar
Water temperature	5°C ÷ 50°C

REF.	DESCRIPTION
RF73A	Electronic Volumetric Softening Valve (LED)

SPARE PARTS

REF.	DESCRIPTION
RF09967	European Power Adapter
RFP9999	Upper Screen ¾" Bajonet

F63 Runxin Residential Down Flow Softening Valves



- Electronic programmable valve, suitable for automatic and residential water softening systems;
- Valve body in NSF listed Noryl plastic material;
- Operating system based on two high design ceramic discs;
- Regeneration DF; Resin volume range = 40 ÷ 150 liters;
- Operating flow rate Kv = 3,13; Backwash flow rate Kv = 1,25;
- Available in chronometric or volumetric versions;
- With Green Injector mounted (Purple and White Injectors included), European transformer 12/230V – 50Hz, upper screen, n.1 Base Seal O-ring, n.1 Drain Hose Connector, n.1 Brine Tube Hose Connector, n.1 Tube Bushing and n.1 Brine Line Flow Control);
- Others injectors and accessories not included, to order separately (please, see the data sheet 01-06-01-EN).



REF.
RF63B1

Characteristics	
Tank size	10" ÷ 18"
In / Out connections	Threaded 1" female (male optional included)
Pressure vessel connection	Threaded 2 ½" - 8 UN male
Drain line connection	Threaded ½" male
Brine line connection	Threaded ¾" BSPT male
Distributor tube O. D. diameter	1,05" (= 27 mm)
Distributor tube length above pressure vessel	0 ± 2 mm
Weight (valve + controller)	2,34 kg
Operating pressure	1,5 ÷ 6,0 bar
Water temperature	5°C ÷ 50°C

REF.	DESCRIPTION
RF63B1 (*)	Electronic Chronometric Softening Valve (LED)
RF63D1 (*)	Electronic Chronometric Softening Valve (LCD)
RF63P1Y (*)	Electronic Chronometric Softening Valve (Indicator) with By-pass
RF63B3 (*)	Electronic Volumetric Softening Valve (LED)
RF63C3	Electronic Volumetric Softening Valve (LED)
RF63C3/F70AL	Electronic Volumetric Softening Valve (LED) with By-pass
RF63D3 (*)	Electronic Volumetric Softening Valve (LCD)
RF63D3/F70AL (*)	Electronic Volumetric Softening Valve (LCD) with By-pass
RF63P3/F70A	Electronic Volumetric Softening Valve (Indicator) with By-pass

SPECIFIC ACCESSORIES

(*) currently not available in stock.

REF.	DESCRIPTION
RF70A	By-pass for RF63 and RF68 Valves
RF70AL	By-pass with Turbine for RF63 and RF68 Valves

SPARE PARTS

REF.	DESCRIPTION
RF09967	European Power Adapter
RFP9999	Upper Screen ¾" Bajonet

F82B-LCD Runxin Residential Volumetric Valves



- Electronic volumetric programmable valve, suitable for automatic and residential water softening systems;
- Valve body in NSF listed Noryl plastic material;
- Operating system based on two high design ceramic discs;
- Regeneration DF or UF;
- Operating flow rate Kv = 3,13;
- Backwash flow rate Kv = 1,25;
- Resin volume range = 40 ÷ 150 liters;
- With White Injector mounted (Red, Black and Orange Injectors included), European transformer 12/230V – 50Hz, upper screen, n.1 Base Seal O-ring, n.1 Drain Hose Connector, n.1 Brine Tube Hose Connector, n.1 Tube Bushing and n.1 Brine Line Flow Control), Meter and Bypass Adjusting Bolt;
- Others injectors and accessories not included, to order separately (please, see the data sheet 01-06-01-EN).



REF.
RF82B-LCD

Characteristics	
Tank size	10" ÷ 18"
In / Out connections	Threaded 1" male
Pressure vessel connection	Threaded 2 1/2" - 8 UN male
Drain line connection	Threaded 1/2" male
Brine line connection	Threaded 3/8" BSPT male
Distributor tube O. D. diameter	1,05" (= 27 mm)
Distributor tube length above pressure vessel	0 ± 2 mm
Weight (valve + controller)	2,72 kg
Operating pressure	1,5 ÷ 6,0 bar
Water temperature	5°C ÷ 50°C

REF.	DESCRIPTION
RF82B-LCD	Electronic Volumetric Softening Valve (LCD)
RF82B-LCD/F70CL (*)	Electronic Volumetric Softening Valve (LCD) with Bypass CL

ACCESSORIES

REF.	DESCRIPTION
RF70CL	By-pass with Turbine for RF63, RF68 and RF82 Valves

SPARE PARTS

REF.	DESCRIPTION
RF09967	EUROPEAN POWER ADAPTER
RFP9999	Upper Screen 3/4" Bajonet

F68 Runxin Residential Up Flow Valves



- Electronic programmable valve, suitable for automatic and residential water softening systems;
- Valve body in NSF listed Noryl plastic material;
- Operating system based on two high design ceramic discs;
- Regeneration UF;
- Operating flow rate Kv = 3,13;
- Backwash flow rate Kv = 1,25;
- Resin volume range = 18 ÷ 150 liters;
- Available in volumetric version;
- With Yellow Injector mounted (Red, Black and Orange Injectors included), European transformer 12/230V – 50Hz, upper screen, n.1 Base Seal O-ring, n.1 Drain Hose Connector, n.1 Brine Tube Hose Connector, n.1 Tube Bushing and n.1 Brine Line Flow Control);
- Others injectors and accessories not included, to order separately (please, see the data sheet 01-06-01-EN).



REF.
RF68C3/F70AL

Characteristics	
Tank size	10" ÷ 18"
In / Out connections	Threaded 1" male
Pressure vessel connection	Threaded 2 ½" - 8 UN male
Drain line connection	Threaded ½" male
Brine line connection	Threaded ⅜" BSPT male
Distributor tube O. D. diameter	1,05" (= 27 mm)
Distributor tube length above pressure vessel	0 ± 2 mm
Weight (valve + controller)	2,90 kg
Operating pressure	1,5 ÷ 6,0 bar
Water temperature	5°C ÷ 50°C

REF.	DESCRIPTION
RF68C3/F70AL (*)	RF68C3 Electronic Volumetric Softening Valve (LED) with By-pass AL
RF68P3Y/F70AL (*)	RF68P3Y Electronic Volumetric Softening Valve (Indicator) with By-pass AL
RF68P3Y/F70CL	RF68P3Y Electronic Volumetric Softening Valve (Indicator) with By-pass CL

SPECIFIC ACCESSORIES

(*) currently not available in stock.

REF.	DESCRIPTION
RF70AL	By-pass with Turbine for RF63 and RF68 Valves
RF70CL	By-pass with Turbine for RF63, RF68 and RF82 Valves

SPARE PARTS

REF.	DESCRIPTION
RF09967	European Power Adapter
RFP9999	Upper Screen ¾" Bajonet

F92A-LED Runxin Residential Up Flow Valve



- Electronic programmable valve, suitable for automatic and residential water softening systems;
- Valve body in NSF listed Noryl plastic material;
- Operating system based on two high design ceramic discs;
- Regeneration UF;
- Operating flow rate Kv = 4,77;
- Backwash flow rate Kv = 1,35;
- Resin volume range = 120 ÷ 300 liters;
- Available in volumetric version;
- With European transformer 12/230V – 50Hz, upper screen, n.1 Base Seal O-ring, n.1 Drain Hose Connector, n.1 Brine Tube Hose Connector, n.1 Tube Bushing and n.1 Brine Line Flow Control.



REF.
RF92A-LED

Characteristics	
Tank size	16" ÷ 24"
In / Out connections	Threaded 1" male
Pressure vessel connection	Threaded 2 ½" - 8 UN male
Drain line connection	Threaded ½" male
Brine line connection	Threaded ¾" BSPT male
Distributor tube O. D. diameter	32 mm
Distributor tube length above pressure vessel	0 ± 2 mm
Weight (valve + controller)	2,72 kg
Operating pressure	1,5 ÷ 6,0 bar
Water temperature	5°C ÷ 50°C

REF.	DESCRIPTION
RF92A-LED	Electronic Volumetric Softening Valve (LED)

SPARE PARTS

REF.	DESCRIPTION
RF09967	European Power Adapter

Runxin Residential Valves Accessories



- Injectors and Accessories not included in the Runxin Residential Valves, to order separately.

SPECIFIC ACCESSORIES

REF.	DESCRIPTION	
RF06301	INJECTOR BROWN + DLFC #1 FOR RUNXIN VALVES - 6301	
RF06302	INJECTOR PINK + DLFC #1 FOR RUNXIN VALVES - 6302	
RF06303	INJECTOR YELLOW + DLFC #2 FOR RUNXIN VALVES - 6303	
RF06304	INJECTOR BLUE + DLFC #2 FOR RUNXIN VALVES - 6304	
RF06305	INJECTOR WHITE + DLFC #3 FOR RUNXIN VALVES - 6305	
RF06306	INJECTOR BLACK + DLFC #3 FOR RUNXIN VALVES - 6306	
RF06307	INJECTOR PURPLE + DLFC #4 FOR RUNXIN VALVES - 6307	
RF06308	INJECTOR RED + DLFC #4 FOR RUNXIN VALVES - 6308	
RF06309	INJECTOR GREEN + DLFC #5 FOR RUNXIN VALVES - 6309	
RF06310	INJECTOR ORANGE + DLFC #5 FOR RUNXIN VALVES - 6310	
RF09995	Service Wrench for Valves - 8484003	
RF47010	Runxin Chlorine Generator	
RF09998	2.5" M/F Adapter with O-ring with Wrench	
RF09997	RF09998 Adapter Wrench	

F74 Runxin Industrial Down Flow Valve



- Electronic programmable valve, suitable for automatic and industrial water softening systems;
- Valve body in NSF listed Noryl plastic material;
- Operating system based on two high design ceramic discs;
- Regeneration DF;
- Operating flow rate Kv = 6,50;
- Backwash flow rate Kv = 3,57;
- Resin volume range = 120 ÷ 450 liters;
- Available in volumetric version;
- With European transformer 12/230V – 50Hz, upper screen, n.1 Base Seal O-ring, n.1 Drain Hose Connector, n.1 Brine Tube Hose Connector, n.1 Tube Bushing and n.1 Brine Line Flow Control.



REF.
RF74A3

Characteristics	
Tank size	21" ÷ 30"
In / Out connections	Threaded 2" male
Pressure vessel connection	Threaded 4" - 8 UN male
Drain line connection	Threaded 1" male
Brine line connection	Threaded ½" BSPT male
Distributor tube O. D. diameter	50 mm
Distributor tube length above pressure vessel	0 ± 2 mm
Weight (valve + controller)	5,88 kg
Operating pressure	2,0 ÷ 6,0 bar
Water temperature	5°C ÷ 50°C

REF.	DESCRIPTION
RF74A3 (*)	Electronic Volumetric Softening Valve (LED)

(*) currently not available in stock.

SPARE PARTS

REF.	DESCRIPTION
RF09967	European Power Adapter

F99 Runxin Industrial Down Flow Valves



- Electronic programmable valve, suitable for automatic and industrial water softening systems;
- Valve body in NSF listed Noryl plastic material;
- Operating system based on two high design ceramic discs;
- Regeneration DF;
- Operating flow rate Kv = 14,4;
- Backwash flow rate Kv = 5,72;
- Resin volume range = 450 ÷ 800 liters;
- Available in chronometric or volumetric versions;
- With European transformer 12/230V – 50Hz, upper screen, n.1 Base Seal O-ring, n.1 Drain Hose Connector, n.1 Brine Tube Hose Connector, n.1 Tube Bushing and n.1 Brine Line Flow Control.



REF.
RF99A3

Characteristics	
Tank size	30" ÷ 42"
In / Out connections	Threaded 2" male
Pressure vessel connection	Threaded 4" - 8 UN male
Drain line connection	Threaded 1,5" male
Brine line connection	Threaded ¾" BSPT male
Distributor tube O. D. diameter	48,3 mm
Distributor tube length above pressure vessel	0 ± 2 mm
Weight (valve + controller)	11,50 kg
Operating pressure	2,0 ÷ 6,0 bar
Water temperature	5°C ÷ 50°C

REF.	DESCRIPTION	
RF99A1 (*)	Electronic Chronometric Softening Valve (LED)	
RF99A3 (*)	Electronic Volumetric Softening Valve (LED)	

(*) currently not available in stock.

SPARE PARTS

REF.	DESCRIPTION	
RF09967	European Power Adapter	

F111 Runxin Industrial Down Flow Valves



- Electronic programmable valve, suitable for automatic and industrial water softening systems;
- Valve body in NSF listed Noryl plastic material;
- Operating system based on two high design ceramic discs;
- Regeneration DF;
- Operating flow rate Kv = 16,71;
- Backwash flow rate Kv = 18,97;
- Resin volume range = 450 ÷ 800 liters;
- Available in chronometric or volumetric versions;
- With European transformer 12/230V – 50Hz, upper screen, n.1 Base Seal O-ring, n.1 Drain Hose Connector, n.1 Brine Tube Hose Connector, n.1 Tube Bushing and n.1 Brine Line Flow Control).



REF.

RF111A3

Characteristics	
Tank size	30" ÷ 48"
In / Out connections	Threaded 2" male
Pressure vessel connection	Threaded 4"- 8 UN male
Drain line connection	Threaded 1,5" male
Brine line connection	Threaded ¾" BSPT male
Distributor tube O. D. diameter	63 mm
Distributor tube length above pressure vessel	0 ± 2 mm
Weight (valve + controller)	11,50 kg
Operating pressure	2,0 ÷ 6,0 bar
Water temperature	5°C ÷ 50°C

REF.	DESCRIPTION	
RF111A1 (*)	Electronic Chronometric Softening Valve (LED)	
RF111A3 (*)	Electronic Volumetric Softening Valve (LED)	

(*) currently not available in stock.

SPARE PARTS

REF.	DESCRIPTION	
RF09967	European Power Adapter	

F75 Runxin Industrial Filter Valve



- Electronic valve, suitable for automatic and industrial water filtering systems;
- Valve body in NSF listed Noryl plastic material;
- Operating system based on two high design ceramic discs;
- Operating flow rate Kv = 8,7;
- Backwash flow rate Kv = 8,0;
- With European transformer 12/230V – 50Hz, upper screen, n.1 Base Seal O-ring, n.1 Drain Hose Connector).



REF.
RF75A

Characteristics	
Tank size	16" ÷ 24"
In / Out connections	Threaded 2" male
Pressure vessel connection	Threaded 4" - 8 UN male
Drain line connection	Threaded 2" male
Distributor tube O. D. diameter	50 mm
Distributor tube length above pressure vessel	0 ± 2 mm
Weight (valve + controller)	4,4 kg
Operating pressure	2,0 ÷ 6,0 bar
Water temperature	5°C ÷ 50°C

REF.	DESCRIPTION
RF75A	Electronic Filtering Valve (LED)

SPARE PARTS

REF.	DESCRIPTION
RF09967	European Power Adapter

Runxin Manual Softening Valves



- Multi-way valves having five functions: service, backwash, brine, fast rinse and refill;
- IN/OUT connections 3/4" BSPP female;
- Drain line connection 1/2" BSPP female;
- Brine line connection 3/8" BSPT male;
- Riser tube diameter 1,05" (26,7 mm);
- Max suggested flow 1,5 m³/h (only valve) @ Δp = 1,75 bar;
- Operating flow rate Kv = 1,09;
- Backwash flow rate Kv = 0,55;
- Max operating pressure 6 bar @ 20°C;
- Max operating temperature 50°C;
- Upper screen included.



REF.
RF64B



REF.
RF64BC



REF.
RF64C

REF.	DF / UF	MOUNTING	
RF64B	DF	Vertical	
RF64BC (*)	DF	Side	
RF64C (*)	UF	Vertical	

- Multi-way valves having five functions: service, backwash, brine, fast rinse and refill;
- IN/OUT connections 1" BSPP female;
- Drain line connection 1/2" BSPP female;
- Brine line connection 3/8" BSPT male;
- Riser tube diameter 1,05" (26,7 mm);
- Max suggested flow 4,5 m³/h (only valve) @ Δp = 1,75 bar;
- Operating flow rate Kv = 3,13;
- Backwash flow rate Kv = 1,25;
- Max operating pressure 6 bar @ 20°C;
- Max operating temperature 50°C;
- Upper screen included.



REF.
RF64A1



REF.
RF64A2



REF.
RF64AC

REF.	DF / UF	MOUNTING	HANDLE MATERIAL	
RF64A1 (*)	DF	Vertical	Metal	
RF64A2 (*)	DF	Vertical	Plastic	
RF64AC (*)	DF	Side	Plastic	

(*) currently not available in stock.

ATTENTION: this multi-way valve is prohibited to change working position with pressure; make sure to shut down pump or close feed valve before rotating the handle to other working position.

Runxin Manual Filter Valves



Max 4 m³/h Multi-way Manual Valve

- Multi-way valve having three functions: filtration, backwash, rinse;
- Fits threaded tanks 2 ½" – 8NPSM;
- IN/OUT connections and drain 1" BSPP female;
- Riser tube diameter 1,05" (26,7 mm);
- Max suggested flow 4 m³/h (only valve);
- Max operating pressure 6 bar @ 20°C;
- Max operating temperature 50°C;
- Upper screen included.



ATTENTION: this multi-way valve is prohibited to change working position with pressure; make sure to shut down pump or close feed valve before rotating the handle to other working position.

REF.	
PV410	

Max 10 m³/h Multi-way Manual Valves

- Multi-way valve having three functions: filtration, backwash, rinse;
- Fits threaded tanks 4" – 8UN;
- IN/OUT connections 2" BSPP female;
- Drain line connection 1,5" BSPP female;
- Riser tube diameter 50 mm;
- Max suggested flow 10 m³/h (only valve) @ Δp = 1,75 bar;
- Operating flow rate Kv = 8,2;
- Backwash flow rate Kv = 6,1;
- Max operating pressure 6 bar @ 20°C;
- Max operating temperature 50°C;
- Upper screen included.



REF.
RF56D1



REF.
RF56D2

REF.	HANDLE MATERIAL	
RF56D1 (*)	Metal	
RF56D2 (*)	Plastic	

(*) currently not available in stock.

ATTENTION: this multi-way valve is prohibited to change working position with pressure; make sure to shut down pump or close feed valve before rotating the handle to other working position.

